







# Table of contents

Welcome to the Indel Webasto Marine Catalogue IM 04	5
Our extensive product range at a glance!	6
What's new	8
<b>CRUISE Marine Refrigerators &amp; Freezers</b>	<b>11</b>
ELEGANCE Refrigerators	12
FREELINE Elegance Refrigerators	14
CLASSIC Refrigerators	18
SILVER Refrigerators	20
INOX Refrigerators	22
INOX COMBI Refrigerators	23
INOX CLEAN TOUCH Refrigerators	25
CLASSIC Freezers	30
INOX Freezers	31
INOX CLEAN TOUCH Freezers	31
<b>DRAWER Marine Refrigerators &amp; Freezers</b>	<b>33</b>
Mini, Inox, Inox Clean Touch, Custom	34
<b>Cooling Boxes</b>	<b>47</b>
Travel Boxes	48
Built-In Boxes	50
<b>Master Data Table</b>	<b>52</b>
<b>Cooling Technology</b>	<b>61</b>
Isotherm ITC Digital Display	62
Isotherm Smart Energy Control	63
Frost-free Technology	65
<b>Cooling Units</b>	<b>67</b>
<b>Special Design</b>	<b>94</b>
Refrigerators and Freezers	94
<b>IceMakers</b>	<b>97</b>
IceMaker DrinkClear	98
IceMaker White	99
<b>Wine Cellars &amp; Cooler</b>	<b>103</b>
<b>Water Heaters</b>	<b>107</b>
Basic, Slim, Square	108
SPA	110
<b>Air Heat Exchangers</b>	<b>113</b>
<b>On Board Safes</b>	<b>117</b>



# Welcome to the Indel Webasto Marine Catalogue IM 04

---

Indel Webasto Marine, based in Novafeltria in Italy, is the successful Joint Venture between the leading automotive supplier Webasto, based in Germany, and the Italian mobile refrigeration leader Indel B. These two companies joined forces to bring high quality galley equipment solutions to marine applications. Indel Webasto Marine stands for high quality products in the marine industry.

## *indel B*

## Webasto

Successful innovations have been reached thanks to a long history of dedicated research and development. Many of these innovations obtained patents and are internationally protected. Our products are produced using exclusively high quality components.

The wide product range consists of refrigerators and freezers, built-in and travel boxes, wine cellars, water boilers, safes and last but not least customized solutions for more comfort on board. Our refrigeration solutions are well acknowledged for their user-friendliness, timeless and innovative design and energy saving engineering.

Our product brand names Isotherm and Isotemp are internationally

known and enjoy an excellent reputation on the market for quality and design. They constitute a major asset for our international distribution network.

Indel Webasto Marine offers a unique value proposition in the marine refrigeration industry, built around three pillars. First of all, our broad product portfolio gives our customers an unrivaled choice of quality products and customization options for the same cut-out dimensions. Second, our long tradition for low electricity consumption products has continuously generated new innovative concepts for energy saving on board, regularly awarded by the industry. Last but not least, our extended, skilled international service network allows a responsive technical support worldwide.



*The production lines in Novafeltria, Italy.*



*Highly skilled workforce.*



*High technology machinery.*

# Our extensive product range at a glance!



## CRUISE Marine Refrigerators

## High-efficiency Refrigerators

<b>Elegance</b>						<b>Freeline</b>					
	CRUISE 42**	CRUISE 49**	CRUISE 65**	CRUISE 85**	CRUISE 130**		ELEGANCE 115				
<b>Classic</b>											
	CRUISE 36	CRUISE 40 Cubic	CRUISE 86	CRUISE 100	CRUISE 130 Drink						
<b>Silver</b>			<b>Inox</b>								
	CRUISE 225	CRUISE 280		CRUISE 36	CRUISE 36 Full Inox	CRUISE 130 Drink**	CRUISE 160 Drink	CRUISE 200**			
<b>Combi</b>					<b>Clean Touch</b>						
	CRUISE 195** Inox	CRUISE 220 Inox	CRUISE 260 Inox	CRUISE 320 Inox		CRUISE 42 Inox	CRUISE 49 Inox	CRUISE 65 Inox	CRUISE 85 Inox	CRUISE 130 Inox	CRUISE 130 Inox Speciale

## CRUISE Marine Freezers

<b>Classic</b>				<b>Inox</b>			<b>Clean Touch</b>	
	CRUISE 63 F	CRUISE 65 F	CRUISE 90 F		CRUISE 63 F	CRUISE 65 F		CRUISE 90 F

## DRAWER Marine Refrigerators & Freezers

<b>Mini</b>							
	DRAWER 16 Silver	DRAWER 16 Black	DRAWER 30 Silver	DRAWER 30 Black	DRAWER 30 White		
<b>Clean Touch</b>							
	DRAWER 42 Inox	DRAWER 49* Inox	DRAWER 65* Inox	DRAWER 70* Inox	DRAWER 85* Inox	DRAWER 100* Inox	DRAWER 130* Inox
<b>Inox</b>							
	DRAWER 55* Freezer Frost-free	DRAWER 65* Frost-free	DRAWER 65 Frost-free Drink	DRAWER 105*	DRAWER 160 Light*	DRAWER 190*	

Inox = stainless steel - \* Custom Panel version available - \*\* Available also with classic doors



## Cooling Boxes

Travel Boxes



TB 13 TB 18

Built-In Boxes



BI 16 BI 29 Dual BI 30 BI 36 BI 40 BI 41 Dual BI 53 BI 75 BI 92 Dual BI 172 Dual

## Energy Saving Technology



Smart Energy Control Intelligent Temperature Control

## Cooling Units

Compact



Air-cooled Water-cooled SP Water-cooled Magnum

SEC



Air-cooled Water-cooled SP Water-cooled Magnum

ITC

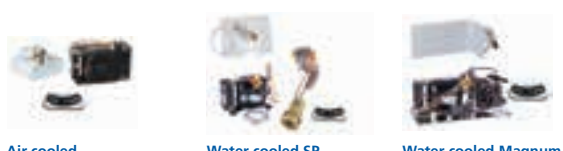

Air-cooled Water-cooled SP Water-cooled Magnum

ITC +

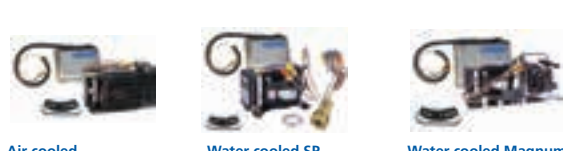

Air-cooled Water-cooled SP Water-cooled Magnum

## Ice Makers

Clear



IceDrink Clear IceDrink Clear WT

White



IceMaker White IceMaker White WT IceMaker White Inox IceMaker Low Profile IceMaker White BI29

## Divino Wine Cellars & Coolers



Wine Cooler Divino The One Wine Cooler Divino The Eight Wine Cellar Divino 23 Wine Cellar Divino 35

## Water Heaters



Basic Slim Square Spa

## Air Heat Exchangers



Air Heat Exchanger

## On Board Safes



Safe 10 Safe 30

## What's new?

---

### Cruise 86

- Compact and performing, only 22 kg weight
- BD Micro compressor technology
- Low power consumption of 0,499kW/24h
- Optional fixing flange



### BI 29 Dual

- Freezer or Fridge: - 20°C + 14°C
- BD Micro compressor technology to minimize installation space and weight
- Easy to use integrated thermostat
- New thermoformed inner liner with built-in foamed evaporator
- Roller slides available as option
- Available in classic door finishing or in custom panel



### BI 36

- Fridge Function: 0°C to + 16°C
- BD Micro compressor technology to minimize installation space and weight
- Large internal basket to plenty store food and drinks
- Thermoformed plastic material inner lining and bottom section
- Upper lid ready for customization



### BI 41 Dual

- Fridge or Freezer: - 22°C + 13°C
- BD Micro compressor technology to minimize installation space and weight
- Easy to use integrated thermostat
- New thermoformed inner liner with built-in foamed evaporator
- Compressor can be removed up to 0,9 meters



**NEW**

**DR 85 and DR 130 Inox Clean Touch: an unbeatable example of style and technology.**

- Two models available: 88 and 130 liters volume
- Robust drawer mechanism with internal stainless steel basket
- Large freezer compartment
- Stainless steel door surface treated with special anti-finger print finishing provided with a three side stainless steel flush flange
- Electronic thermostat with integrated LED lights
- 12/24 V SECOP BD "Nano" Compressor, with integrated isotherm Smart energy function
- Tropical climatic class certified with two stars freezer rating (- 12°C)



DR 85 Inox Clean Touch

DR 130 Inox Clean Touch

**VE200 PLUG&PLAY: transform your empty space into a fridge in one simple move**

- Fridge function up to 200 liters volume
- PLUG&PLAY solution, the evaporator and the compressor units are now designed as a single piece to easier the application in one simple move
- 12/24 V SECOP BD 35 F compressor
- The thermostatic control and the ventilated-fan evaporator ensure great cooling performances and a well-balanced temperature inside the cabinet.



**Divino The One: integrated wine cooler**

- Perfect serving temperature for your wine
- Elegant integrated design
- Upper crown can now be customized in two different finishings: polished and brushed stainless steel
- 27 LED-light color effects
- Cool with a dry air jacket: no more wet bottles and water stains
- Performing and reliable: 3 years warranty
- High quality materials



**IceMaker White WT Inox Clean Touch.**

**Ice, design and convenience for all boat applications:**

- Anti-fingerprint Inox Clean Touch door finishing
- AC/DC solution capable to produce and maintain ice in both power supplies
- Removable water tank easy to clean and refill
- Automatic low power setting mode in DC
- Standard 3 sides flush fixing flange



## Reliable Marine refrigerators and freezers

Isotherm CRUISE refrigerators and freezers are the result of a careful research. Marine refrigerators operate under tough conditions: they must withstand violent movements, operate noiselessly, be thoroughly reliable and last but not least consume an absolute minimum of battery power.

# CRUISE Marine Refrigerators & Freezers

<b>CRUISE Elegance Refrigerators</b>	<b>12</b>
ELEGANCE 42, 49, 65	14
ELEGANCE 85, 130	15
<hr/>	
<b>FREELINE Elegance Refrigerators</b>	<b>15</b>
FREELINE 115 EL	15
<hr/>	
<b>CRUISE Classic Refrigerators</b>	<b>16</b>
CRUISE 36, 40 Cubic, 86	18
CRUISE 100, 130 Drink	19
<hr/>	
<b>CRUISE Silver Refrigerators</b>	<b>20</b>
SILVER 225, 280	20
<hr/>	
<b>CRUISE Inox Refrigerators</b>	<b>21</b>
CRUISE 36, 36 Full Inox, 130 Drink	21
<hr/>	
<b>CRUISE Inox Refrigerators</b>	<b>22</b>
160 Drink, 200	22
<hr/>	
<b>CRUISE Inox Combi Line</b>	<b>23</b>
COMBI INOX 195, 220	23
COMBI INOX 260, 320	24
<hr/>	
<b>CRUISE Inox Clean Touch Refrigerators</b>	<b>25</b>
INOX CLEAN TOUCH 42, 49, 65	26
INOX CLEAN TOUCH 85, 130, 130 Speciale	27
<hr/>	
<b>CRUISE Classic, Inox, Inox Clean Touch Freezers</b>	<b>28</b>
CLASSIC 63 F, 65 F, 90 F	30
INOX 63 F, 65 F	31
INOX CLEAN TOUCH 90 F	31

# CRUISE Elegance Marine Refrigerators

Designing and building high quality, energy efficient marine refrigeration systems exclusively made for sailing yachts and motor cruisers is our visit card. The CRUISE Elegance Marine refrigerators are available in five sizes starting from 42 liters up to 130 liters capacity. Infinite design opportunities such as customizable door panels and handles meet customers' expectations which results in a completely in line interior boat design.

## The ultimate combination of style and technology!



- 5 volumes: 42, 49, 65, 85, 130 liters
- Ready for Isotherm SEC and ITC
- Innovative vent-lock system
- Easy-fix installation solutions
- Customizable door panel and handle
- Reliability: Secop compressors
- Extra-thick insulation for low power consumption
- White internal LED light

## Choose our Isotherm CRUISE Elegance fridge to enjoy endless tailor-made options.

- Standard customized options:



*White*

*Black*

*Teak*

*Wengè*

*White oak*

## Fully customized design available on request.

For any inquiries about the availability of finishes, also regarding Cruise Classic version, please contact IWM directly.

## Cruise Elegance Marine Refrigerators

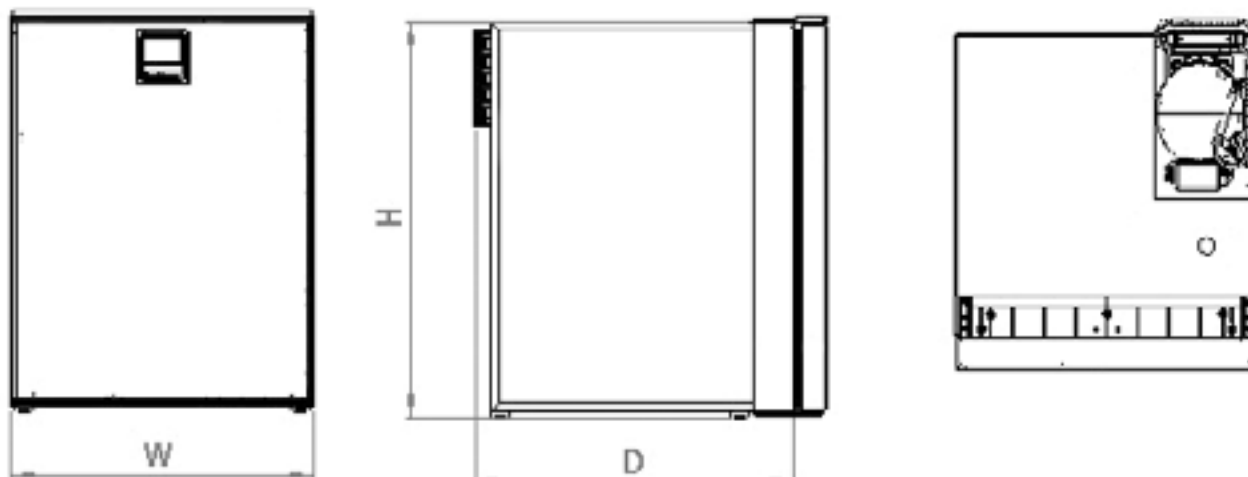



**Vent-lock system**

Thanks to an invisible mechanism made with a simple slide, CRUISE Elegance fridges can be switched to ventilation mode.

The door remains slightly open while the fridge is switched off.



**Easy-fix installation solution**



The cabinet can be directly installed from the interior of the fridge thanks to the easy fix installation system. The external flange is no longer needed for the installation. An innovative internal bushing structure prevents the crushing of the insulated side wall.

**Product highlights:**

- A new handle designed to open large sized doors from the middle
- Easy and quick customizable door panels and handles
- A wide choice available from our stock – special requests can also be processed. (> 300 options)
- Branding/Logo on handle can be added on request

**Product overview: Isotherm CRUISE Elegance Marine Refrigerators**

Type	Gross volume (l)		Dimensions W x H x D (mm) (A - B)	Weight (kg)	Power consumption (Wh/24h)	Secop compressor type	Freezer compartment specifications
	Fridge	Freezer					
CR 42 EL	37	5	380 x 525 x 455 <sup>(A) (B)</sup>	14	285	BD1.4F-VSD	± (-6)
CR 49 EL	44	5	380 x 525 x 452 <sup>(B)</sup>	17	265	BD35F	± (-6)
CR 65 EL	60	5	450 x 530 x 473 <sup>(B)</sup>	18	275	BD35F	± (-6)
CR 85 EL	77	8	475 x 627 x 505 <sup>(B)</sup>	22	368	BD35F	± (-6)
CR 130 EL	122	8	525 x 750 x 510 <sup>(B)</sup>	27	418	BD35F	± (-6)
Freeline 115 EL	83	32	525 x 797 x 495 <sup>(B)</sup>	29	257	BD35F	± (-6)

(A) Depth decreases when removing the compressor.  
 (B) Door thickness not included.  
 For further details please refer to the master data table.

# CRUISE Elegance

42, 49, 65



## CRUISE 42 EL

The CR 42 EL is the smallest fridge of the CRUISE Elegance line. The fridge has a new inner lining with one adjustable shelf and two door shelf bins, as well as a 5 liters freezer compartment with a magnetic steel evaporator door. The compressor, installed at the back of the cabinet, can be removed up to 1 meter.

\* Depth only 350 mm when compressor is remote  
50 mm door's thickness not included

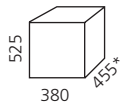

Isotherm CRUISE 42 EL	
Weight (Kg)	14
Gross volume (l)	42

ORDER NUMBER	DESCRIPTION
C042RSAAS11111A1	FRIDGE CRUISE ELEGANCE SILVER 42/V



## CRUISE 49 EL

The CR 49 EL has a new inner lining with one adjustable shelf and two door shelf bins as well as a freezer compartment with a volume of 5 liters with magnetic steel evaporator door.

\* 50 mm door's thickness not included

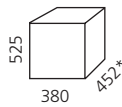

Isotherm CRUISE 49 EL	
Weight (Kg)	17
Gross volume (l)	49

ORDER NUMBER	DESCRIPTION
C049RSAAS11111AA	FRIDGE CRUISE ELEGANCE SILVER 42/V



## CRUISE 65 EL

The CR 65 EL fridge is based on the same inner lining as the CR 49 EL which includes one adjustable shelf and two door shelf bins. It also has a freezer compartment with a volume of 5 liters. Magnetic stainless steel evaporator door.

\* 50 mm door's thickness not included

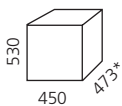

Isotherm CRUISE 65 EL	
Weight (Kg)	18
Gross volume (l)	65

ORDER NUMBER	DESCRIPTION
C065RSAAS11111AA	FRIDGE CRUISE ELEGANCE SILVER 65/V

# CRUISE Elegance

85, 130, Freeline 115



### CRUISE 85 EL

The CR 85 EL offers the customer a 8 liter freezer compartment, two adjustable shelves and two door shelf bins. It is set up for Isotherm Smart Energy Control, like all other CRUISE Elegance fridges. Magnetic stainless steel evaporator door.

\* 50 mm door's thickness not included

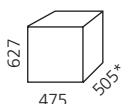

Isotherm CRUISE 85 EL	
Weight (Kg)	22
Gross volume (l)	85

ORDER NUMBER	DESCRIPTION
C085RSAAS11111AA	FRIDGE CRUISE ELEGANCE SILVER 42/V



### CRUISE 130 EL

The CR 130 EL has a 8 liters separated freezer compartment, two adjustable shelves and three retainers inside the door. It is equipped with a vegetable bin covered by two glass shelves. Magnetic stainless steel evaporator door.

\* 50 mm door's thickness not included

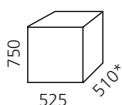

Isotherm CRUISE 130 EL	
Weight (Kg)	27
Gross volume (l)	130

ORDER NUMBER	DESCRIPTION
C130RSAAS11111AA	FRIDGE CRUISE ELEGANCE SILVER 130/V



### FREELINE 115 EL

FREELINE 115 liters Elegance provides 83 liters capacity as fridge and 32 liters as freezer. The freezer compartment allows massive food storage thanks to its full width design; it may contain 4 pizza boxes. It has a modern control panel with LED lights, flush mounted in the cabinet, which allows an easy fridge operation for selecting the temperature and reading the error codes. ECO function like the overcooling mode allows to store cold energy in food and drinks making a surplus of power available. Extremely low power consumption (267W) can be reached due to extra-thick insulation and its integrated ECO function.

\* 50 mm door's thickness not included

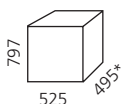

Isotherm FREELINE 115	
Weight (Kg)	29
Gross volume (l)	115

ORDER NUMBER	DESCRIPTION
F115RSAAS11111AA	FRIDGE FREELINE ELEGANCE 115/V

# CRUISE Classic, Silver, Inox, Combi Marine Refrigerators

Isotherm CRUISE Refrigerators combine technological innovation with sophisticated yet practical design. The CRUISE Classic refrigerators are available from 36 liters up to 320 liters and provide various customizable options.

## Extremely robust yet practical in use

### Common Product Features:

- Freezer compartment (not on Drink versions)
- High customization level of door and flange design
- Equipped with interior light
- Installation flange (optional on Cruise Classic and Elegance)
- Very low power consumption
- 12/24 V Secop compressor
- Door with a safety lock and magnetic rubber seal



CRUISE 36 FULL INOX

### Some standard features of the Cruise Inox Line:

- Different side flanges: 2 up to 3 side flanges for an easy installation and 3 up to 4 side flanges for a complete flush integration
- Complete stainless steel design (doors and handles)
- Different cooling systems: ventilated as standard, water-cooled with a self pumping kit (patented) and water-cooled through a sea water pump for tropical conditions as option



CRUISE 160 DRINK INOX

### Some standard features of the Cruise Classic line:

- Fan-cooled 12/24 V Secop compressor
- Custom door panels to complement any interior (grey door as standard)
- Freezer compartment (except Drink versions)
- One piece inner lining of high density food-grade plastic with rounded corners for easy cleaning
- Constructed of corrosion resistant materials
- Interior light (not on CR 36, CR 100)
- Magnetic rubber seals keep moisture out and the door is firmly closed
- Right hand or left hand side opening is possible\*

### Cruise Marine Refrigerators Classic

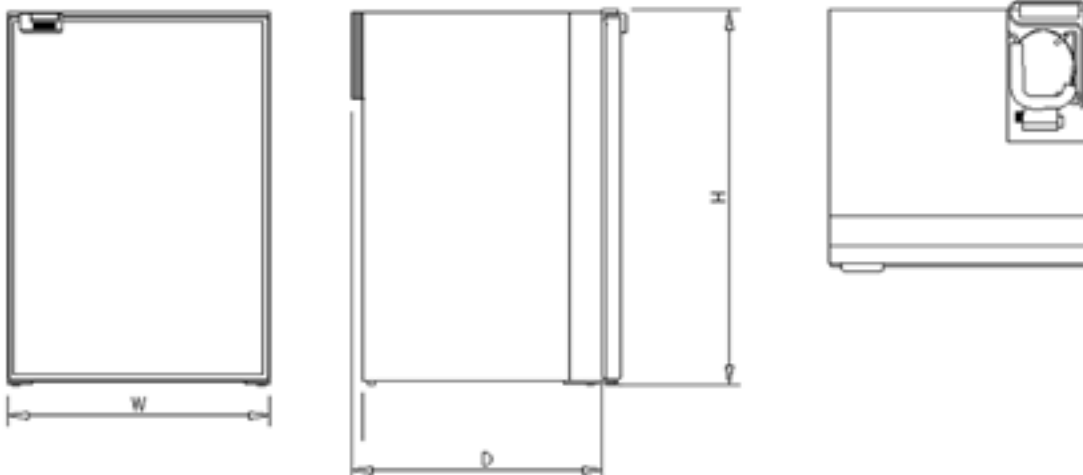

\*Due to the door latch position on some CRUISE Stainless Steel Inox line models (CR 90 Freezer, CR 130 Drink, CR 130 and CR 195), right or left swing must be stated when ordering





**Cruise Marine Refrigerators Inox**

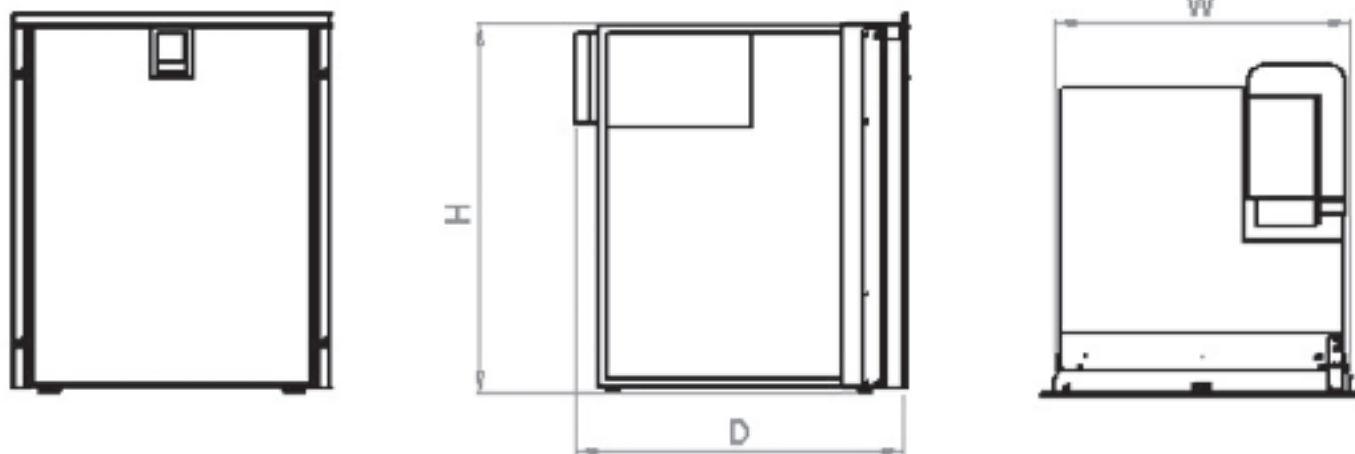

**Product Overview: Isotherm CRUISE Marine Refrigerators**

Type	Gross volume (l)		Dimensions W x H x D (mm) (A - B)	Available with		Weight (kg) (C)	Power consumption Wh/24h	Secop compressor type	Freezer compartment specifications
	Fridge	Freezer		SEC	ITC				
CR 36 Classic	36	–	440 x 250 x 685 <sup>(A)(B)</sup>			16	300	BD35F	–
CR 36 Inox / 36 Full Inox	36	–	455 x 255 x 715 <sup>(A)</sup>			17	300	BD35F	–
CR 40 Cubic	40		420 x 435 x 585 <sup>(A)(B)</sup>			18	186	BD35F	+++ (-12°C)
CR 42 Classic	37	5	380 x 525 x 455 <sup>(A)(B)</sup>			14	300	BD1.4F-VSD	+ (-6°C)
CR 49 Classic	44	5	380 x 525 x 452 <sup>(B)</sup>	X	X	17	278	BD35F	+ (-6°C)
CR 65 Classic	60	5	450 x 530 x 473 <sup>(B)</sup>	X	X	18	288	BD35F	+ (-6°C)
CR 85 Classic	77	8	475 x 627 x 505 <sup>(B)</sup>	X	X	22	386	BD35F	+ (-6°C)
CR 86 Classic	76	10	380 x 850 x 495 <sup>(B)</sup>			22	499	BD1.4F-VSD	+ (-6°C)
CR 100 Classic	94	6	486 x 745 x 455 <sup>(B)</sup>	X	X	23	400	BD35F	+ (-6°C)
CR 130 Classic	122	8	525 x 750 x 510 <sup>(B)</sup>	X	X	27	438	BD35F	+ (-6°C)
CR 130 Drink	130	–	527 x 750 x 520 <sup>(B)</sup>	X	X	27	400	BD35F	–
CR 130 Drink Inox	130	–	544 x 750 x 560	X	X	32	400	BD35F	–
CR 160 Drink Inox	160	–	626 x 870 x 610	X	X	45	512	BD50F	–
CR 195 Combi Classic	130	65	551 x 1347 x 565	X <sup>(C)</sup>	X <sup>(C)</sup>	54	840	2 x BD35F	++++ (-18°C)
CR 195 Combi Inox	130	65	544 x 1347 x 565	X <sup>(C)</sup>	X <sup>(C)</sup>	54	840	2 x BD35F	++++ (-18°C)
CR 200 Classic	150	50	731 x 880 x 620			47	874	BD50F	+++ (-12°C)
CR 200 Inox	150	50	731 x 880 x 620			48	874	BD50F	+++ (-12°C)
CR 220 Combi Inox	130	90	544 x 1545 x 560	X <sup>(C)</sup>	X <sup>(C)</sup>	61	1070	2 x BD35F	++++ (-18°C)
CR 225 Silver	188	45	547 x 1444 x 486 <sup>(B)</sup>			36	630	BD50F	++++ (-18°C)
CR 260 Combi Inox	244	16	544 x 1545 x 560	X	X	64	836	2 x BD35F	+ (-6°C)
CR 280 Silver	235	45	547 x 1700 x 486 <sup>(B)</sup>			41	680	BD50F	++++ (-18°C)
CR 320 Combi Inox			628 x 1790 x 610	X <sup>(C)</sup>	X <sup>(C)</sup>	84			
Fridge/Fridge	320						1042	2 x BD50F	–
Fridge/Freezer	250	70					1147	BD50F + BD80F	+ (-6°C)
Fridge/Freezer	160	160					1609	BD50F + BD80F	+++ (-12°C)

(A) Depth decreases when removing the compressor.

(B) Door thickness not included.

(C) Available for fridge compartment only.

For further details please refer to the master data table.

# CRUISE Classic

36, 40 Cubic, 86

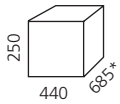

Isotherm CRUISE 36	
Weight (Kg)	16
Gross volume (l)	36

ORDER NUMBER	DESCRIPTION
1036BA1G00000	FRIDGE CRUISE WHITE 36/V

## CRUISE 36

The CR 36 is a built-in drawer fridge with unique design. Thanks to its compact size, the CR 36 can be installed where no other fridge might fit. The compressor can be removed up to 1.20 meters. It comes with a white door and mounting flange as standard.

\* Depth only 556 mm when compressor is remote  
35 mm door's thickness not included

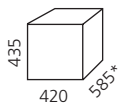

Isotherm CRUISE 40 Cubic	
Weight (Kg)	18
Gross volume (l)	40

ORDER NUMBER	DESCRIPTION
1040BB1AC0000	FRIDGE OR FREEZER CRUISE CUBIC 40/V

## CRUISE 40 Cubic

The CR 40 Cubic has a fridge or freezer function. It can be installed as a front opening fridge or freezer (Cruise) or as a top-opening fridge or freezer (Built-In box). As a standard installation, the CR 40 Cubic is an ordinary front-opening fridge or freezer. By changing position, it can be top-opening cockpit mounted, fridge or freezer, like other products of the Isotherm Built-in line. The compressor can be removed up to 1 meter.

\* Depth only 460 mm when compressor is remote  
40 mm door's thickness not included

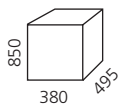

Isotherm CRUISE 86	
Weight (Kg)	22
Gross volume (l)	86

ORDER NUMBER	DESCRIPTION
C086RBABN11111AA	FRIDGE CRUISE CLASSIC BLACK PANEL 86/V

## CRUISE 86

The Cruise 86 is a refrigeration solution of 86 liters gross volume, equipped with a 10 liters freezer compartment.

It stands out for the reliable BD Micro compressor technology, that contributes to its low weight of 22 kg and to a low energy consumption of 0,499kW/24h.

Its "slim line design" makes possible applications in narrow spaces, with the easiness of an optional modular mounting flange.

# CRUISE Classic

100, 130 Drink



### CRUISE 100

The CR 100 is characterized by air ducts and a ventilated compressor that enables circulation even in tight installations. Additional mounting flanges are available as an option.

\* 40 mm door's thickness not included

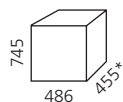

Isotherm CRUISE 100	
Weight (Kg)	23
Gross volume (l)	100

ORDER NUMBER	DESCRIPTION
1100BA1AA0000	FRIDGE CRUISE 100/V



### CRUISE 130 Drink

The CR 130 D is a special version of the CR 130 that offers the customer to have extra space for drinks instead of a freezer compartment. It is equipped with an interior light and a fan that allows cold air to circulate in the fridge. Wine bottle racks are available as option.

\* 40 mm door's thickness not included

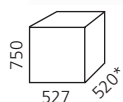

Isotherm CRUISE 130 Drink	
Weight (Kg)	27
Gross volume (l)	130

ORDER NUMBER	DESCRIPTION
1130BA1AA0000	FRIDGE CRUISE DRINK 130/V

# CRUISE Silver

225, 280



**NEW**

## CRUISE 225 Silver

The CR 225 is a two door fridge-freezer solution. The refrigerator has a volume of 183 liters while the freezer 42 liters. The fridge is equipped with an interior light, three shelves and two vegetable bins at the bottom.

\* 70 mm door's thickness not included

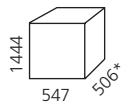

Isotherm CRUISE 225	
Weight (Kg)	36
Gross volume (l)	180 + 45

ORDER NUMBER	DESCRIPTION
C225RNASP14111AA	FRIDGE AND FREEZER SILVER CR225/V



**NEW**

## CRUISE 280 Silver

The CR 280 is a two door fridge-freezer solution. The refrigerator has a volume of 238 liters and the freezer 42 liters. The fridge is equipped with an interior light, four shelves and two vegetable bins at the bottom.

\* 70 mm door's thickness not included

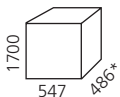

Isotherm CRUISE 280	
Weight (Kg)	41
Gross volume (l)	235 + 45

ORDER NUMBER	DESCRIPTION
C280RNASP14111AA	FRIDGE AND FREEZER CRUISE SILVER CR280/V

# CRUISE Inox

36, 36 Full Inox, 130 Drink

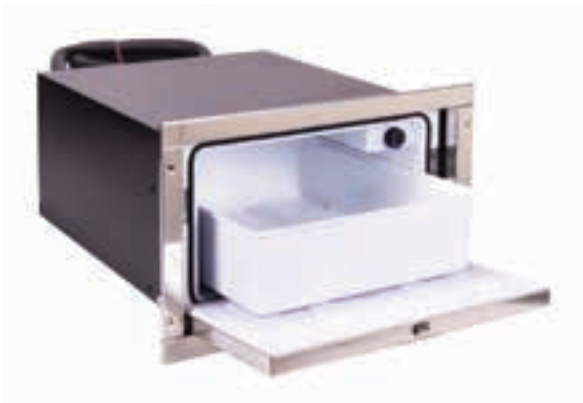

### CRUISE 36 Inox

The CR 36 Inox is a built-in drawer fridge with unique design. Thanks to its compact size, the CR 36 Inox can be installed where no other fridge might fit. The compressor can be removed up to 1.20 meters. The Inox model comes with a four side flush mounting flange as standard.

\* Depth only 585 mm when compressor is remote

**For application in open deck areas we recommend the use of the FULL INOX version, with cabinet's body in stainless steel**

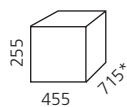

Isotherm CRUISE 36 Inox	
Weight (Kg)	17
Gross volume (l)	36

ORDER NUMBER	DESCRIPTION
1036BA1EK0000	FRIDGE CRUISE INOX 36/V
1036BA1EK0012	FRIDGE CRUISE INOX 36/V FULL INOX



### CRUISE 130 Drink Inox

The CR 130 D Inox is the stainless steel design version of the CR 130 D that offers the customer to have extra space for drinks instead of a freezer compartment. It is equipped with an interior light and a fan that allows cold air to circulate inside the fridge.

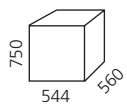

Isotherm CRUISE 130 Drink Inox	
Weight (Kg)	32
Gross volume (l)	130

ORDER NUMBER	DESCRIPTION
1130BA1MK0000	FRIDGE CRUISE DRINK INOX 130/V

# CRUISE Inox

## 160 Drink, 200



### CRUISE 160 Drink Inox

The CR 160 D Inox is a stainless steel fridge unit, specifically designed to offer spacious on board storage for drinks and beverage, keeping them always at the right temperature thanks to the ventilated evaporator on the back. It is equipped with an elegant LED light and it is available with right or left hinged door nicely integrated thanks to the 3-sided mounting flange. Having the same cut-out dimensions of the Drawer 160 Inox light, it is ideal for a side by side application.

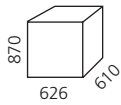

Isotherm CRUISE 160 Drink Inox	
Weight (Kg)	45
Gross volume (l)	160

ORDER NUMBER	DESCRIPTION
C160RNEIA12111AA	FRIDGE CRUISE DRINK INOX 160/V



### CRUISE 200 Inox

The CR 200 Inox is a stylish new fridge-freezer in stainless steel design that has been developed to offer spacious on board storage for fresh and frozen foods. It is designed for easy installation under the work surface. The CR 200 Inox is divided into a 150 liters volume fridge section and a 50 liters volume freezer section.

\* Available also with classic doors

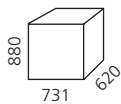

Isotherm CRUISE 200 Inox	
Weight (Kg)	48
Gross volume (l)	200

ORDER NUMBER	DESCRIPTION
1200BB1XK0000	FRIDGE AND FREEZER CRUISE INOX 200/V

# CRUISE Combi Inox

195, 220

COMBI Line Available as	
1. Refrigerator	1
2. Freezer	2
3. Ice Maker	3
4. Refrigerator with freezer compartment	4



- 1
- 2

## CRUISE 195 Combi Inox

The CR 195 Inox is a two door fridge-freezer solution combining a CR 130 refrigerator and a 65 liters freezer. The refrigerator comes with interior light and a vegetable bin. CR195 Inox is equipped with two fan-cooled compressors, separate thermostats for the fridge and freezer sections and is delivered with a flush mounting flange.

\* Available also with classic doors

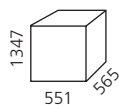

Isotherm CRUISE 195 Combi	
Weight (Kg)	54
Gross volume (l)	130 + 65

ORDER NUMBER	DESCRIPTION
1195BB1MK0000	FRIDGE AND FREEZER CRUISE COMBI INOX 195/V



- 1
- 2

## CRUISE 220 Combi Inox

The CR 220 Inox is a two door fridge-freezer solution in stainless steel, combining a CR 130 fridge on top of a CR 90 liters freezer. Equipped with two fan-cooled compressors with separate thermostats, this combination grants maximum cooling performance. An elegant flush flange is provided, with inner ventilation grilles to easier condenser's cool down process.

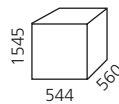

Isotherm CRUISE 220 Combi	
Weight (Kg)	61
Gross volume (l)	130+90

ORDER NUMBER	DESCRIPTION
C220RNEIA14111AA	FRIDGE AND FREEZER CRUISE COMBI INOX 220/V

# CRUISE Combi Inox

260, 320

## COMBI Line Available as

- 1. Refrigerator
- 2. Freezer
- 3. Ice Maker
- 4. Refrigerator with freezer compartment

1
2
3
4



1
4

### CRUISE 260 Combi Inox

The CR 260 Inox is a spacious fridge-fridge solution designed for big vessels. A CR 130 drink refrigerator is positioned on the top, with a practical Drawer 130 liter fridge unit at the bottom. The hybrid combinations of front opening door and the bottom drawer concept gives the CR 260 a stylish and practical impression. The Drawer 130 it is provided with a drawer mechanism with a freezer compartment included. It can be delivered with an optional 4th side flange with off-shore lock included.

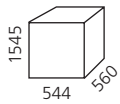

Isotherm CRUISE 260 Combi	
Weight (Kg)	64
Gross volume (l)	130+130

ORDER NUMBER	DESCRIPTION
C260ANEIA11111AA	FRIDGE CRUISE COMBI INOX 260/V



1	1	1
1	1	2
1	2	2

### CRUISE 320 Combi Inox

The CR 320 Inox is an hybrid modular unit which combines a large capacity of liters with a practical and elegant appearance. The Cruise 160 Drink is positioned on the top while a double drawer unit is located at the bottom. As per current configuration possibilities, DR 160 Inox can be supplied in tree versions: both drawers as a fridge, both drawers as a freezer, one drawer fridge and the other freezer.

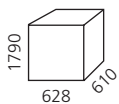

Isotherm CRUISE 320 Combi	
Weight (Kg)	85
Gross volume (l)	160+160

ORDER NUMBER	DESCRIPTION
C320ANEIA1A111AA	FRIDGE, FRIDGE AND FRIDGE CRUISE COMBI INOX 320/V
C320ANEIA1B111AA	FRIDGE, FRIDGE AND FREEZER CRUISE COMBI INOX 320/V
C320ANEIA1C111AA	FRIDGE, FREEZER AND FREEZER CRUISE COMBI INOX 320/V



# CRUISE Inox Clean Touch Marine Refrigerators



The Inox Clean Touch range represents the latest evolution of the world-renowned Elegance product line. It combines the features of the Cruise Elegance line (except the Vent-Lock system) with a new door design in stainless steel especially treated to avoid fingerprints (Inox anti-fingerprint). This new material combines a cutting-edge marine design with a very simple cleaning and maintenance of the refrigerator. The handle of the Elegance line is flush mounted into a new door and is centrally located to allow easy switch of the hinge opening side.



- 5 volumes: 42, 49, 65, 85, 130 liters
- 3 sides flush mounting flange as standard, 4th side as optional
- High quality stainless steel balcony profiles
- Ready for Isotherm Smart Energy Control & ITC
- Easy fix installation solution
- Reliability: Secop compressors
- Extra-thick insulation for low power consumption
- White LED internal light



Available on some models

## Product Overview: Isotherm CRUISE Inox Clean Touch Marine Refrigerators

Type	Gross volume (l)		Dimensions W x H x D (mm) (A)	Available with SEC and ITC	Weight (kg)	Power consumption (Wh/24h)	Secop compressor type	Freezer compartment specifications
CR 42 Inox Clean Touch	37	5	400 x 525 x 500 <sup>(A)</sup>		15	285	BD1.4F-VSD	⊖ (-6°C)
CR 49 Inox Clean Touch	44	5	400 x 525 x 500	X	18	265	BD35F	⊖ (-6°C)
CR 65 Inox Clean Touch	60	5	470 x 530 x 520	X	19	275	BD35F	⊖ (-6°C)
CR 85 Inox Clean Touch	77	8	495 x 627 x 550	X	24	368	BD35F	⊖ (-6°C)
CR 130 Inox Clean Touch	122	8	545 x 750 x 555	X	29	418	BD35F	⊖ (-6°C)
CR 130 Inox Clean Touch Speciale	122	8	545 x 794 x 585	X	31	418	BD35F	⊖ (-6°C)

(A) Depth decreases when remoting the compressor.  
For further details please refer to the master data table.

# CRUISE Inox Clean Touch

42, 49, 65



## CRUISE 42 Inox Clean Touch

The CR 42 Inox Clean Touch is the stainless steel design version of the CR 42. The compressor unit on the back can be moved up to 1 meter. It is equipped with an installation flange and an interior LED light, as standard.

\* Depth only 400 mm when compressor is remote

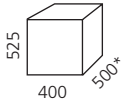

### Isotherm CRUISE 42 Inox Clean Touch

Weight (Kg)	15
Gross volume (l)	42

ORDER NUMBER	DESCRIPTION
C042RNEIT11111AA	FRIDGE CRUISE INOX CLEAN TOUCH 42/V



## CRUISE 49 Inox Clean Touch

The CR 49 Inox Clean Touch is the stainless steel design version of the CR 49. It has the built-in compressor that allows an easier installation. It offers the possibility to store PET bottles horizontally and vertically. It is equipped with an installation flange and an interior LED light, as standard.

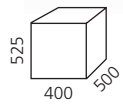

### Isotherm CRUISE 49 Inox Clean Touch

Weight (Kg)	18
Gross volume (l)	49

ORDER NUMBER	DESCRIPTION
C049RNEIT11111AA	FRIDGE CRUISE INOX CLEAN TOUCH 49/V



## CRUISE 65 Inox Clean Touch

The CR 65 Inox Clean Touch is the stainless steel design version of the CR 65. It features a separated freezer compartment and a built-in compressor unit. It is equipped with an installation flange and an interior LED light, as standard.

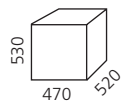

### Isotherm CRUISE 65 Inox Clean Touch

Weight (Kg)	19
Gross volume (l)	65

ORDER NUMBER	DESCRIPTION
C065RNEIT11111AA	FRIDGE CRUISE INOX CLEAN TOUCH 65/V

# CRUISE Inox Clean Touch

85, 130, 130 Speciale



### CRUISE 85 Inox Clean Touch

The CR 85 Inox Clean Touch is the stainless steel design version of the CR 85. It provides a freezer compartment, two adjustable shelves and a corner-mounted compressor. It is equipped with an installation flange and an interior LED light, as standard.

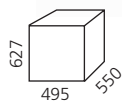

Isotherm CRUISE 85 Inox Clean Touch	
Weight (Kg)	24
Gross volume (l)	85

ORDER NUMBER	DESCRIPTION
C085RNEIT11111AA	FRIDGE CRUISE INOX CLEAN TOUCH 85/V



### CRUISE 130 Inox Clean Touch

The CR 130 Inox Clean Touch is the stainless steel design version of the CR 130 that provides a freezer compartment, a vegetable bin and three door shelf bins. It is equipped with interior LED light and a fan cooled compressor as standard.

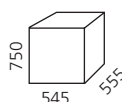

Isotherm CRUISE 130 Inox Clean Touch	
Weight (Kg)	29
Gross volume (l)	130

ORDER NUMBER	DESCRIPTION
C130RNEIT11111AA	FRIDGE CRUISE INOX CLEAN TOUCH 130/V



### Cruise 130 Inox Clean Touch Speciale

The Cruise 130 Inox Clean Touch Speciale is a dedicated version of the CR 130 Inox Clean Touch in stainless steel design that provides two additional exclusive features. Its flush mounting flange is engineered with an integrated top grille which together with a custom design air conveyor grants the full rear installation recess and a safe venting of the product. At the bottom of the cabinet, a large bin provides a drainage system for moisture accumulated during use.

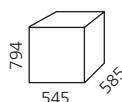

Isotherm CRUISE 130 Inox Clean Touch Speciale	
Weight (Kg)	31
Gross volume (l)	130

ORDER NUMBER	DESCRIPTION
C130RNNIT11111AA	FRIDGE CRUISE INOX CLEAN TOUCH SPECIALE 130/V - FLANGE 3 SIDES + 4 <sup>TH</sup> SIDE IN BOX

# CRUISE Classic, Inox & Inox Clean Touch Marine Freezers

---

The Isotherm CRUISE freezer units are the perfect complement to CRUISE refrigerators. The high-quality freezers ensures a perfect and constant temperature to keep frozen foods on board.



- Extra thick insulation for excellent cooling performance and low power consumption
- 12/24 V Secop compressor
- Door with safety lock and magnetic rubber seal
- Excellent solution for a side by side fridge-freezer application
- Isotherm Power Pack ready for AC/DC application

## Cruise Marine Freezers Classic

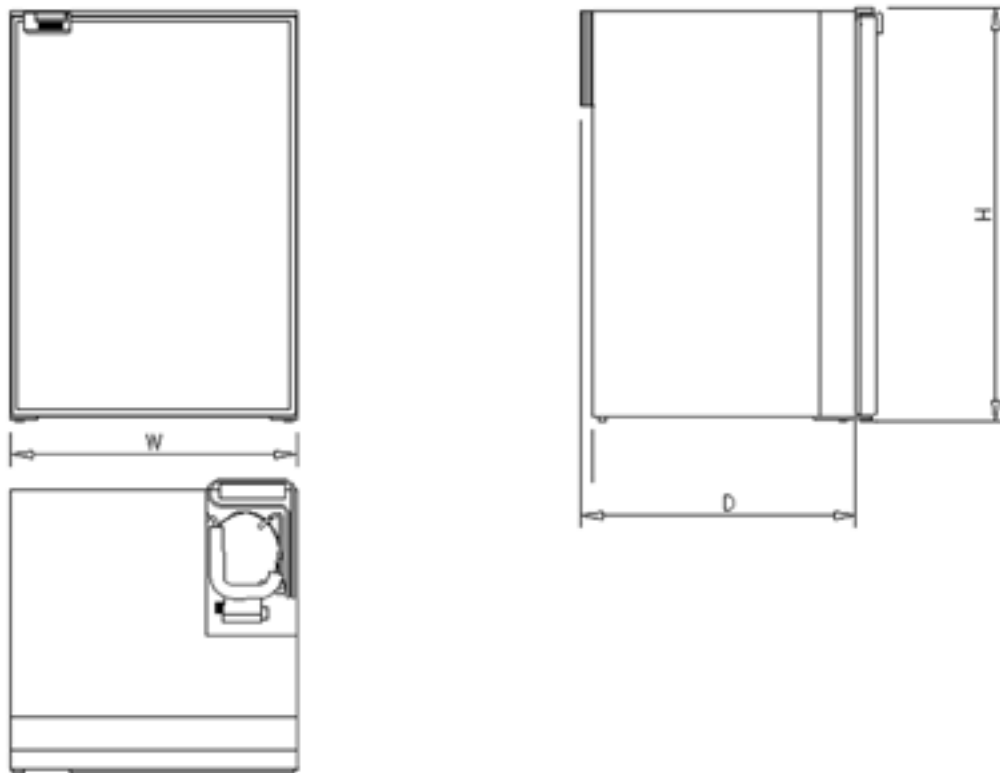

**Cruise Marine Freezers Inox**

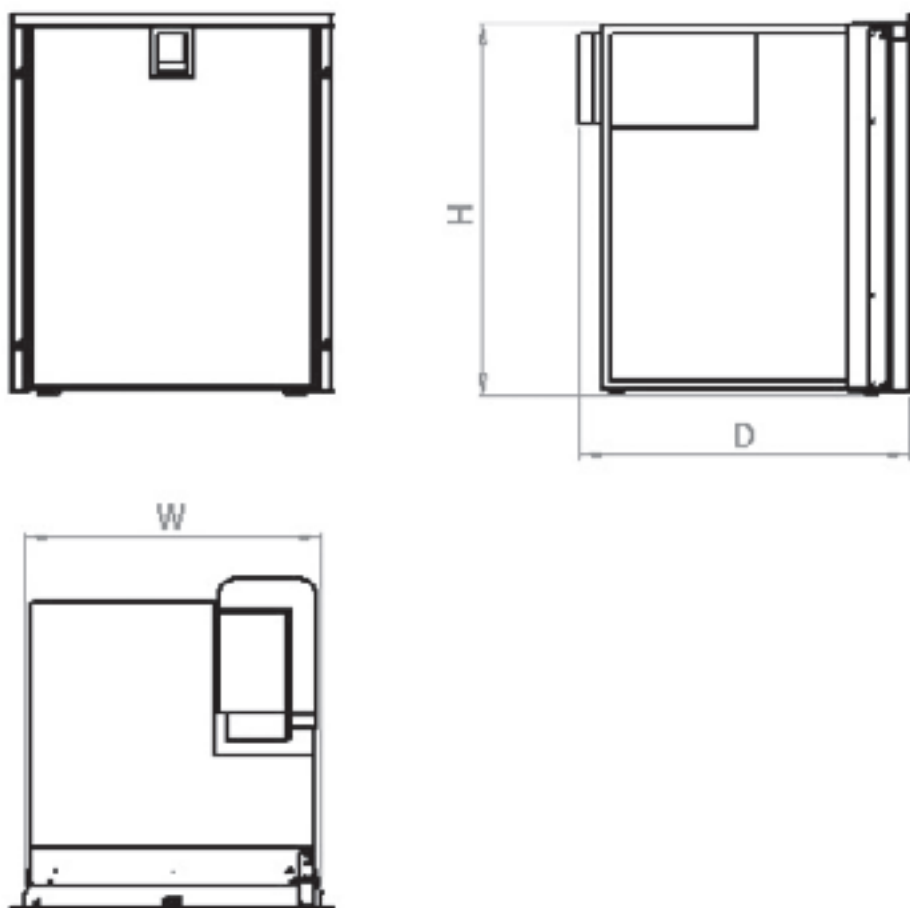

**Product Overview: Isotherm CRUISE Marine Freezers**

Type	Gross volume (l)	Dimensions W x H x D (mm) (B)	Weight (kg)	Power consumption (Wh/24h)	Secop compressor type	Freezer compartment specifications
CR 63 F	63	475 x 620 x 513 <sup>(B)</sup>	23	440	BD35F	*** (-18°C)
CR 63 F Inox	63	494 x 623 x 552	25	440	BD35F	*** (-18°C)
CR 65 F	65	525 x 610 x 540 <sup>(B)</sup>	25	458	BD35F	*** (-18°C)
CR 65 F Inox	65	544 x 610 x 580	27	458	BD35F	*** (-18°C)
CR 90 F	90	525 x 750 x 515 <sup>(B)</sup>	26	670	BD35F	** (-12°C)
CR 90 F Inox Clean Touch	90	545 x 750 x 565	28	626	BD35F	** (-12°C)

(B) Door thickness not included.  
For further details please refer to the master data table.

# CRUISE Classic

63 F, 65 F, 90 F



### CRUISE 63 Freezer

The CR 63 Freezer can be perfectly installed side by side to the CR 85 Fridge version as they have the same outside dimensions. CR 63 F is equipped with two shelves and a bin at the bottom. It has a corner-mounted compressor and the evaporator piping is integrated in the walls.

\* 40 mm door's thickness not included

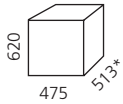

Isotherm CRUISE 63 Freezer	
Weight (Kg)	23
Gross volume (l)	63

ORDER NUMBER	DESCRIPTION
1063BC1AA0000	FREEZER CRUISE 63/V



### CRUISE 65 Freezer

The CR 65 Freezer is a 65 liters volume freezer with extra thick insulation. It is equipped with one shelf and a plastic basket at the bottom. The CR 65 F is delivered with a fan-cooled compressor.

\* 40 mm door's thickness not included

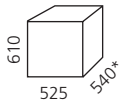

Isotherm CRUISE 65 Freezer	
Weight (Kg)	25
Gross volume (l)	65

ORDER NUMBER	DESCRIPTION
1065BC1AA0000	FREEZER CRUISE 65/V



### CRUISE 90 Freezer

The CR 90 Freezer can be perfectly installed side by side to the CR 130 Fridge version as they have the same outside dimensions. The CR 90 F is equipped with three shelves and four separate lids. It is delivered with a fan-cooled compressor. The top compartment operates as chiller (0 to -3°C).

\* 40 mm door's thickness not included

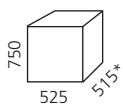

Isotherm CRUISE 90 Freezer	
Weight (Kg)	26
Gross volume (l)	90

ORDER NUMBER	DESCRIPTION
1090BC1AA0000	FREEZER CRUISE 90/V

# CRUISE Inox & Clean Touch

63 F, 65 F, 90 F



### CRUISE 63 Freezer Inox

CR 63 F Inox is equipped with two shelves and a bin at the bottom. It has a corner-mounted compressor and the evaporator piping is integrated in the walls.

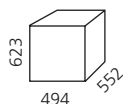

Isotherm CRUISE 63 Freezer Inox	
Weight (Kg)	25
Gross volume (l)	63

ORDER NUMBER	DESCRIPTION
1063BC1MK0000	FREEZER CRUISE INOX 63/V



### CRUISE 65 Freezer Inox

The CR 65 Freezer Inox is a 65 liters volume freezer with extra thick insulation. It is equipped with one shelf and a plastic basket at the bottom. The CR 65 F is delivered with a fan-cooled compressor.

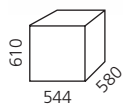

Isotherm CRUISE 65 Freezer Inox	
Weight (Kg)	27
Gross volume (l)	65

ORDER NUMBER	DESCRIPTION
1065BC1MK0000	FREEZER CR65/V INOX WITH FLUSH MOUNTING 12/24V



### CRUISE 90 FREEZER Inox Clean Touch

The CR 90 Freezer Inox Clean Touch has a door in stainless steel especially treated to avoid fingerprints (Inox anti-fingerprint materiale). It can be perfectly installed side by side to the CR 130 fridge Inox Clean Touch as they have the same outside dimensions (just 1 cm deeper). The CR 90 Freezer Inox Clean Touch is equipped with three shelves and four separate lids. It is delivered with a fan-cooled compressor as standard. The top compartment operates as chiller (0 to -3°C).

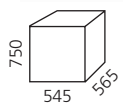

Isotherm CRUISE 90 Freezer Inox Clean Touch	
Weight (Kg)	28
Gross volume (l)	90

ORDER NUMBER	DESCRIPTION
C090RNEIT13111AA	FREEZER CRUISE INOX CLEAN TOUCH 90/V



## Easy access to drinks and food: the Isotherm drawer fridges and freezers

The convenient drawer openings allow an easy access to food and drinks.  
An extraordinary stylish design rounds up these highly functional units.



## DRAWER Marine Refrigerators & Freezers

### DRAWER MINI

DRAWER 16 Silver	37
DRAWER 16 Black	37
DRAWER 30 Silver	37
DRAWER 30 Black	38
DRAWER 30 White	38

---

### DRAWER INOX, INOX CLEAN TOUCH, CUSTOM

DRAWER 42 Inox Clean Touch	39
DRAWER 49 Inox Clean Touch	39
DRAWER 55 Inox Frost-free	40
DRAWER 65 Inox Frost-free	40
DRAWER 65 Inox Frost-free Drink	41
DRAWER 65 Inox Clean Touch	41
DRAWER 70 Inox Clean Touch	42
DRAWER 85 Inox Clean Touch	42
DRAWER 100 Inox Clean Touch	43
DRAWER 105 Inox	43
DRAWER 130 Inox Clean Touch	44
DRAWER 160 Inox Light	44
DRAWER 190 Inox	45

---

# DRAWER Marine Refrigerators & Freezers

---

## Drawer technology for best daily use!

Isotherm drawer fridges and freezers stand for great design and user-friendliness. High-quality materials and sturdy construction ensure long service life.



- High-tech design
- Easy access for a comfortable use
- Freezer compartment (-6°C)
- Robust drawer mechanism
- Removable drawers for easy cleaning
- Unique Frost-free feature on some models



Available on some models

### Special features of the drawer line include:

- Different side flanges: 3 to 4 side flanges available to ensure a flush mounting installation
- Different cooling systems: ventilated as standard, water-cooled with a self pumping kit (patented) and water-cooled through a sea water pump for tropical conditions
- Isotherm Power Pack available for AC/DC application to enable worldwide power supply
- Customized flanges for side by side applications
- The innovative Isotherm off shore lock prevents accidental opening of the door
- Available with the award winning Frost-free concept that ensures greater energy efficiency: ice buildup and the resulting higher energy consumption are prevented



## Drawer Inox Clean Touch: when marine design meets unmatched user comfort.

The exclusive Inox Clean Touch technology, made of a stainless steel door specially treated to avoid fingerprints, is now combined with the easy-to-use drawer mechanism. The elegant interior atmosphere created by the strip of 5 LED lights goes perfectly with the practical internal dividers.

- Exclusive Inox Clean Touch finishing
- Robust and practical drawer mechanism
- 3-sided stainless steel mounting flange available as standard
- 7 models available: 42, 49, 65, 70, 85, 100 and 130 liters



Available on some models

## Drawer Customization concept:

Indel Webasto Marine offers its customers even more possibilities for customization. On models 49, 55, 65, 70, 85, 130, 160 and 190 it is now possible to customize the door front. The drawer fridge or freezer comes with a specially foamed door ready to be customized, such as with a real wood panel (customer-supplied). The panel fixing kit is provided with the product. Thanks to this new technology it is now possible to select both panel finish and handle design according to the interior of the boat.

- Perfect integration into the interior design
- Optional door panel mounting brackets
- Side-by-side installation of fridge and freezer
- Customizable safety door locks

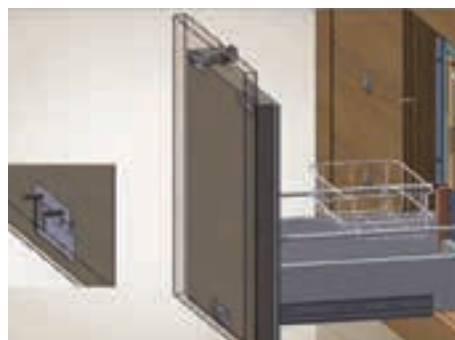

# DRAWER Marine Refrigerators & Freezers

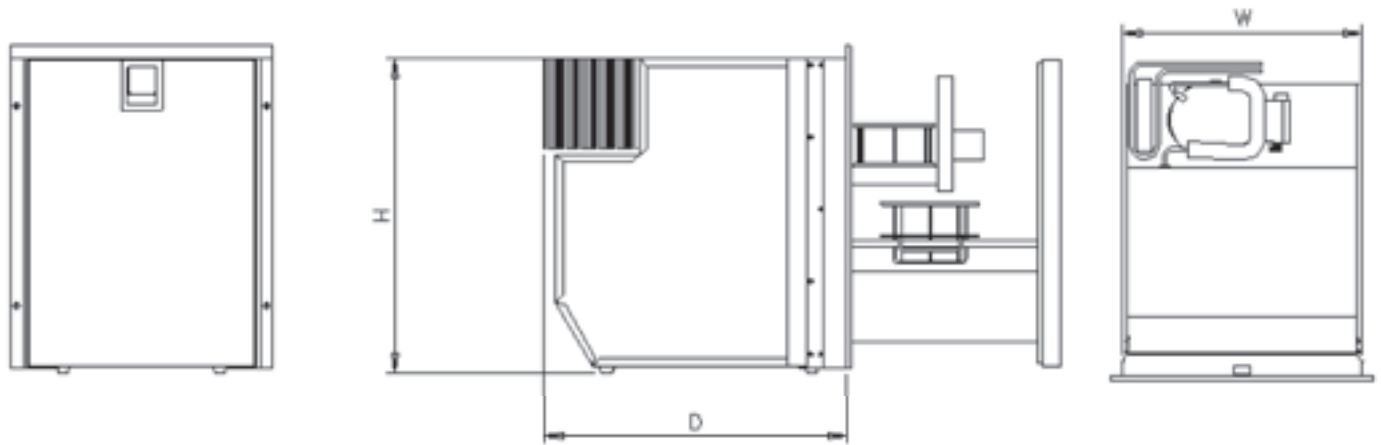

## Product Overview: Isotherm Drawer Marine Refrigerators and Freezers

Type	Gross volume (l)		Dimensions W x H x D (mm) (A)	Weight (kg)	Power consumption (Wh/24h)	Secop compressor type	Freezer compartment specifications
	Fridge	Freezer					
DR 16	16		380 x 250 x 540 <sup>(A)</sup>	13	252	BD1.4F-FSD	± (-6°C)
DR 30	30	–	440 x 260 x 700 <sup>(A)</sup>	17	244	BD1.4F-FSD	–
DR 42 Inox Clean Touch	34	8	399 x 519 x 511	18	333	BD1.4F-VSD	± (-6°C)
DR 49 Inox Clean Touch	41	8	399 x 519 x 497	18	305	BD1.4F-VSD	± (-6°C)
DR 55 Inox Freezer Frost-free	–	55	469 x 525 x 555	27	741	BD35F	± ± (-12°C)
DR 65 Inox Frost Free Drink	65	–	469 x 525 x 555	27	310	BD35F	–
DR 65 Inox Frost-free	65	–	469 x 525 x 555	26	310	BD35F	–
DR 65 Inox Clean Touch	54	11	470 x 525 x 520	21	324	BD1.4F-VSD	± (-6°C)
DR 70 Inox Clean Touch Fridge	70	–	626 x 444 x 724	31	295	BD35F	–
DR 70 Inox Clean Touch Freezer	–	70	627 x 444 x 724	32	800	BD50F	± ± (-12°C)
DR 70 Inox Clean Touch Freezer - Ice Maker*	–	60	627 x 444 x 786 <sup>(A)</sup>	38	1055	TLES5.7FT.3	± ± (-12°C)
DR 70 Inox Clean Touch Freezer - Ice Maker**	–	60	627 x 444 x 786 <sup>(A)</sup>	38	1380	TLS4.5F	± ± (-12°C)
DR 85 Inox Clean Touch	88	13	494 x 619 x 544	23	300	BDN45F	± ± (-12°C)
DR 100 Inox Clean Touch Fridge	100	–	546 x 501 x 778	31	252	BD35F	± (-6°C)
DR 100 Inox Clean Touch Freezer	–	100	546 x 501 x 778	33	503	BD50F	± ± (-12°C)
DR 100 Inox Clean Touch Freezer - Ice Maker*	–	90	546 x 501 x 840	39	790	TLES5.7FT.3	± ± (-12°C)
DR 100 Inox Clean Touch Freezer - Ice Maker**	–	90	546 x 501 x 840	39	1031	TLS4.5F	± ± (-12°C)
DR 105 Inox	105	–	515 x 515 x 575+170	28	480	BD35F	–
DR 130 Inox Clean Touch	124	14	544 x 744 x 551	27	N/A	BDN45F	± (-6°C)
DR 160 Inox Light Fridge Only	160	–	627 x 865 x 610	43	530	BD50F	–
DR 160 Inox Light Freezer Only	–	160	627 x 865 x 610	45	1097	BD80F	± ± (-12°C)
DR 160 Inox Light Fridge Freezer	90	70	627 x 865 x 610	46	635	BD80F	± (-6°C)
DR 190 Inox	190	–	900 x 800 x 545	56	700	BD50F	–

\* Power supply 230 V AC - 50 Hz.

\*\* Power supply 115 V AC - 60 Hz.

(A) Depth decreases when removing the compressor.

For further details please refer to the master data table.

# DRAWER Mini

## Marine Refrigerator & Freezer

### 16 Silver, 30 Black, 30 Silver



\* 240 without feet

#### DRAWER 16 Silver

The smallest and lightest drawer unit available on the market, with a user-friendly digital interface which matches perfectly with the highly appreciated Elegance design thanks to the product line's features such as the easy fix installation. The stainless steel door is painted in silver colour and the rails are in stainless steel too (AISI 304). It can be used as a fridge or freezer (-6°C). Being equipped with BD 1.4F Secop compressor, it requires a minimum installation space.

\*\* Depth only 440 when compressor is remote

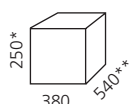

Isotherm DRAWER 16 Silver	
Weight (Kg)	13
Gross volume (l)	16

ORDER NUMBER	DESCRIPTION
D016DSAAS1211AA	DRAWER FRIDGE SILVER 16/V



**NEW**

\* 240 without feet

#### DRAWER 16 Black

The smallest and lightest drawer unit available on the market, with a user-friendly digital interface which matches perfectly with the highly appreciated Elegance design thanks to the product line's features such as the easy fix installation. The stainless steel door is painted in black colour and the rails are in stainless steel too (AISI 304). It can be used as a fridge or freezer (-6°C). Being equipped with BD 1.4F Secop compressor, it requires a minimum installation space.

\*\* Depth only 440 when compressor is remote

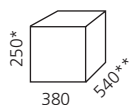

Isotherm DRAWER 16 Black	
Weight (Kg)	13
Gross volume (l)	16

ORDER NUMBER	DESCRIPTION
D016DBAAB1211AA	DRAWER FRIDGE BLACK 16/V

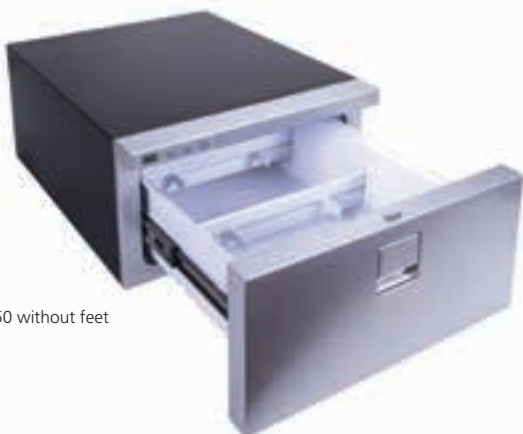

\* 250 without feet

#### DRAWER 30 Silver

The Drawer 30 Silver premium version is a drawer refrigerator with a user-friendly digital interface which matches perfectly with the highly appreciated Elegance design thanks to the product's line features such as the easy fix installation. The stainless steel door is painted in silver colour and the rails are in stainless steel too (AISI 304). Equipped with BD 1.4F Secop compressor, it requires a minimum installation space.

\*\* Depth only 600 when compressor is remote

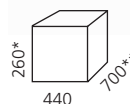

Isotherm DRAWER 30 Silver	
Weight (Kg)	17
Gross volume (l)	30

ORDER NUMBER	DESCRIPTION
D030DSAAS1211AA	DRAWER FRIDGE SILVER 30/V

# DRAWER Mini

## Marine Refrigerator & Freezer

### 30 Black, 30 White



\* 250 without feet

#### DRAWER 30 Black

The Drawer 30 Black premium version is a drawer refrigerator with a user-friendly digital interface which matches perfectly with the highly appreciated Elegance design thanks to the product's line features such as the easy fix installation. The stainless steel door is painted in black colour and the rails are in stainless steel too (AISI 304). Equipped with BD 1.4F Secop compressor, it requires a minimum installation space.

\*\* Depth only 600 when compressor is remote

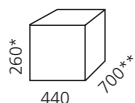

Isotherm DRAWER 30 Black	
Weight (Kg)	17
Gross volume (l)	30

ORDER NUMBER	DESCRIPTION
D030DBAAB12111AA	DRAWER FRIDGE BLACK 30/V



\* 250 without feet

#### DRAWER 30 White

The Drawer 30 White premium version is a drawer refrigerator with a user-friendly digital interface which matches perfectly with the highly appreciated Elegance design thanks to the product's line features such as the easy fix installation. The stainless steel door is painted in white colour and the rails are in stainless steel too (AISI 304). Equipped with BD 1.4F Secop compressor, it requires a minimum installation space.

\*\* Depth only 600 when compressor is remote

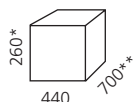

Isotherm DRAWER 30 White	
Weight (Kg)	17
Gross volume (l)	30

ORDER NUMBER	DESCRIPTION
D030DWAAW12111AA	DRAWER FRIDGE WHITE 30/V

# DRAWER Inox Clean Touch

Marine Refrigerator & Freezer

42, 49 Inox Clean Touch



## DRAWER 42 Inox Clean Touch

The Drawer 42 Inox Clean Touch is a drawer refrigerator solution with freezer compartment, characterized by compact external dimensions. The Inox Clean Touch finishing in stainless steel AISI 304 has an outstanding look and feel and a long lasting clean effect. It will surprise you with its interior practicality, thanks to an easy to use thermostat with five integrated LED lights and a robust drawer mechanism. The BD Micro Secop compressor can be easily removed from cabinet's back up to 1 meter thus its standard 3-sided mounting flange grants perfect on board integration.

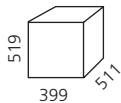

Isotherm DRAWER 42 Inox Clean Touch	
Weight (Kg)	18
Gross volume (l)	42

ORDER NUMBER	DESCRIPTION
D042DNEIT1111AA	DRAWER FRIDGE INOX CLEAN-TOUCH 42(II)/V



## DRAWER 49 Inox Clean Touch

The Drawer 49 Inox Clean Touch is a space-saving drawer unit in stainless steel. The Inox Clean Touch feature (stainless steel AISI 304 which is specially treated to avoid fingerprints) will make your life easier, thanks to the perfect product fitting as well as a long-lasting clean effect. The interior is designed to suit international cans and food packs, with a robust drawer mechanism. It is provided with an easy to use electronic thermostat, with five LED light integrated. Completed with a large freezer compartment and a 3-sided mounting flange. Available with the CUSTOM PANEL door option.

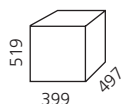

Isotherm DRAWER 49 Inox Clean Touch	
Weight (Kg)	18
Gross volume (l)	49

ORDER NUMBER	DESCRIPTION
D049DNEIT1111AA	DRAWER FRIDGE INOX CLEAN-TOUCH 49(II)/V
D049DNLCP1111AA	DRAWER FRIDGE CUSTOM 49(II)/VV

# DRAWER Inox

## Marine Refrigerators & Freezers

### 55 Frost Free, 65 Frost Free



#### DRAWER 55 Inox Frost-free Freezer

The DR 55 freezer is a 55 liters capacity stainless steel front opened drawer freezer. This model combines innovative stainless steel design with the most modern technology such as automatic defrost which allows the comfort of home on board. The DR 55 F is equipped with an internal fan for temperature constant control and a sequence of 5 LED lights for blue internal light. Available with the CUSTOM PANEL door option.

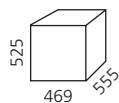

Isotherm DRAWER 55 Inox Frost-free Freezer	
Weight (Kg)	27
Gross volume (l)	55

ORDER NUMBER	DESCRIPTION
3055BH2C00000	FREEZER DRAWER INOX NO FROST 55/V



#### DRAWER 65 Inox Frost-free

The DR 65 Inox is a space-saving, front-opened drawer, providing a volume of 65 liters with bins and bottle racks. It is the ideal solution for a side by side installation with the DR 55 Inox freezer. It combines the modern technology with automatic defrost which allows the comfort of home on board. For a constant temperature control, an internal fan is mounted. A sequence of 5 LED lights provides blue internal light. Available with the CUSTOM PANEL door option.

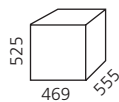

Isotherm DRAWER 65 Inox Frost-free	
Weight (Kg)	26
Gross volume (l)	65

ORDER NUMBER	DESCRIPTION
3065BG2C00000	FRIDGE DRAWER INOX NO FROST 65/V



# DRAWER Inox, Inox Clean Touch

## Marine Refrigerator & Freezer

### 65 Frost Free Drink, 65



#### DRAWER 65 Inox Frost Free Drink

The Drawer 65 Inox Frost Free Drink is an exclusive front-opened drawer solution designed to offer spacious on board storage for drinks and beverage. The Frost Free technology with its ventilated evaporator ensure perfect cold air circulation in the cabinet, keeping drinks always at the right temperature. It is equipped with a sequence of 5 blue LED lights with a 4-sided mounting flange not-installed in box included.

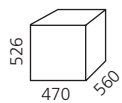

Isotherm DRAWER 65 Inox Frost-free Drink	
Weight (Kg)	27
Gross volume (l)	65

ORDER NUMBER	DESCRIPTION
3065BG2C00116	FRIDGE DRAWER INOX NO FROST 65/V - 4 <sup>TH</sup> SIDE IN BOX DRINK VERSION



#### DRAWER 65 Inox Clean Touch

The Drawer 65 Inox Clean Touch combines the well-known advantages of the premium Clean Touch stainless steel finish with an innovative interior concept of baskets, bottle racks and a large freezer compartment. Compact and performing, the Drawer 65 is also suitable with the new BD 1.4F VSD by SECOP 12/24V Micro compressor, provided as well with an innovative, easy to use electronic thermostat. A 3-sided mounting flange and the renewed CUSTOM PANEL door option make it easy to install and integrate into customer's furniture.

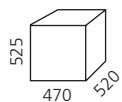

Isotherm DRAWER 65 Inox Clean Touch	
Weight (Kg)	21
Gross volume (l)	65

ORDER NUMBER	DESCRIPTION
D065DNEIT11111AA	DRAWER FRIDGE INOX CLEAN-TOUCH 65(II)/V
D065DNLCP11111AA	DRAWER FRIDGE CUSTOM 65(II)/V

# DRAWER Inox Clean Touch

## Marine Refrigerators & Freezers

70, 85



### DRAWER 70 Inox Clean Touch

The DR70 Inox Clean Touch is the premium front-opened drawer solution with a stainless steel door especially treated to avoid fingerprints. This new material combines a state of the art marine design with easy cleaning and maintenance of the refrigerator. It has a robust drawer mechanism, 5 blue led lights and internal baskets, to offer great comfort in use. The 3-sided mounting flange in stainless steel allows an easy recess in furniture. The compressor can be removed up to 1,1 meters. It is available in three different versions as fridge (DC), freezer (DC) and freezer with Ice Maker integrated (AC), all of them available with CUSTOM PANEL option.

\* Depth only 610 mm when compressor is remote

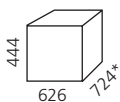

Isotherm DRAWER 70 Inox Clean Touch	
Weight (Kg)	31
Gross volume (l)	70

ORDER NUMBER	DESCRIPTION
D070DNEIT12111AA	DRAWER FRIDGE INOX CLEAN-TOUCH 70/V
D070DNEIT13111AA	DRAWER FREEZER INOX CLEAN-TOUCH 70/V
D070DNEIT55112AA	DRAWER FREEZER WITH ICE-MAKER INTEGRATED 230V INOX CLEAN-TOUCH 70/V
D070DNEIT65113AA	DRAWER FREEZER WITH ICE-MAKER INTEGRATED 115V INOX CLEAN-TOUCH 70/V



### DRAWER 85 Inox Clean Touch

The Drawer 85 Inox Clean Touch is a drawer refrigeration solution with a gross volume of 88 liters, equipped with a large 12-liter net internal freezer compartment. This premium product features a stainless steel door specially treated to prevent fingerprints, mounted on a robust drawer mechanism. A three side stainless steel fixing flange, available as standard, allows easy fitting and excellent on-board integration. The new Secop compressor BDN45F "Nano" installed power grants a bigger and a more practical cabinet's interior, thanks to its compact size and high cooling efficiency. Inside it has a removable stainless steel basket to create additional storage space and an easy-to-use electronic thermostat with 5 LED lights integrated, for great comfort in use. AC/DC compatibility is granted through the use of the Isotherm Power Pack, available as optional as well as the bottom fixing flange and the custom panel door.

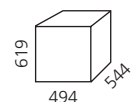

Isotherm DRAWER 85 Inox Clean Touch	
Weight (Kg)	23
Gross volume (l)	88

ORDER NUMBER	DESCRIPTION
D085DNEIT11111AA	DRAWER FRIDGE INOX CLEAN TOUCH 85(II)/V
D085DNLCP11111AA	DRAWER FRIDGE CUSTOM 85(II)/V

# DRAWER Inox, Inox Clean Touch

Marine Refrigerators & Freezers

100, 105



## Drawer 100 Inox Clean Touch

The Drawer 100 Inox Clean Touch is a large single door solution with the exclusive advantages of the anti-fingerprint stainless steel and of an unbeatable practicality and comfort in use. A robust drawer mechanism, a dedicated inner basket system and 5 blue led lights make it ideal when great comfort is desired. The 3-sided mounting flange in stainless steel and its remote compressor options grant perfect on board integration. It is available in three different versions, as fridge (DC), freezer (DC) and freezer with Ice Maker integrated (AC). All versions are available with the CUSTOM PANEL door option.

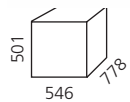

Isotherm DRAWER 100 Inox Clean Touch	
Weight (Kg)	32
Gross volume (l)	100

ORDER NUMBER	DESCRIPTION
D100DNEIT12111AA	DRAWER FRIDGE INOX CLEAN-TOUCH 100/V
D100DNLCP12111AA	DRAWER FRIDGE CUSTOM 100/V
D100DNEIT13111AA	DRAWER FREEZER INOX CLEAN-TOUCH 100/V
D100DNLCP13111AA	DRAWER FREEZER CUSTOM 100/V



## DRAWER 105 Inox

The DR 105 Inox drawer fridge gives opportunities for installations where a normal refrigerator would not fit. It can be installed as the main galley fridge, as a cockpit bar or even on the fly-bridge. The front panel is available in stainless steel or as a raw foamed drawer front with the option of mounting individual wooden front panels in line with the interior design of the boat. The compressor can be remoted up to 1,5 meters.

\* DR105 sold already with remote compressor

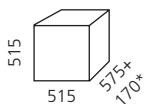

Isotherm DRAWER 105 Inox	
Weight (Kg)	28
Gross volume (l)	105

ORDER NUMBER	DESCRIPTION
3105BA2C00006	DRAWER FRIDGE INOX FRONT INOX 105/V - REMOTE UNIT 2m X-COUPPLINGS

# DRAWER Inox, Inox Clean Touch

## Marine Refrigerators & Freezers

### 130, 160 Light



#### DRAWER 130 Inox Clean Touch

The Drawer 130 Inox Clean Touch is a 124-liter gross volume drawer refrigeration solution with a large 13-liter net internal freezer compartment.

The Inox Clean Touch feature (AISI 304 stainless steel specially treated to prevent fingerprints) provides a long-lasting clean look and feel. Easy to integrate thanks to the three-sided stainless steel fixing flange, available as standard.

The new Secop BDN45F „Nano“ compressor combines high cooling performance with low energy consumption thanks to an easy-to-use electronic thermostat with 5 built-in LED lights. It has a removable stainless steel basket to create additional storage space.

AC/DC compatibility is granted through the use of the Isotherm Power Pack, available as optional as well as the bottom fixing flange and the custom panel door.

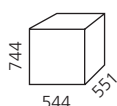

#### Isotherm DRAWER 130 Inox Clean Touch

Weight (Kg)	27
Gross volume (l)	130

ORDER NUMBER	DESCRIPTION
D130DNEIT11111AA	DRAWER FRIDGE INOX CLEAN TOUCH 130(II)/V
D130DNLCP11111AA	DRAWER FRIDGE CUSTOM 130(II)/V



#### DRAWER 160 Inox Light

The DR 160 Inox Light is an evolution of the successful DR160 Inox Combo. This unit operates on 12/24 V and is available in three versions: both drawers as fridges, both drawers as freezers or one drawer as a fridge and one drawer as a freezer. It is equipped with an inner light on fridge and fridge/freezer version while available as option the internal divider kit and the Isotherm Power Pack ready for AC/DC application. Available with the CUSTOM PANEL door option.

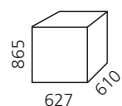

#### Isotherm DRAWER 160 Inox Light

Weight (Kg)	43
Gross volume (l)	160

ORDER NUMBER	DESCRIPTION
3160BA1C00000	FRIDGE DRAWER INOX 160/V
3160BB1CR00000	FRIDGE AND FREEZER DRAWER INOX 160/V
3160BC1C00000	FREEZER DRAWER INOX 160/V

# DRAWER Inox

## Marine Refrigerators & Freezers

190



### DRAWER 190 Inox

The DR 190 Inox is a drawer refrigerator in stainless steel design with two separate drawers that offer convenient adjustable interior equipment. It is equipped with a fan-cooled compressor mounted on the rear side and 3-sided mounting flange for flush mounting. Available with the CUSTOM PANEL door option.

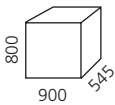

Isotherm DRAWER 190 Inox	
Weight (Kg)	56
Gross volume (l)	190

ORDER NUMBER	DESCRIPTION
3190BA2C00000	FRIDGE DRAWER INOX 190/V





## **For daily use and in extreme conditions**

**No matter where you decide to cruise, Cooling Boxes offer the right cooling solution for your boat or yacht. Travel Boxes are extremely performing and especially convenient for daily use thanks to their light and compact design.**

# Cooling Boxes

<b>Travel Boxes</b>	<b>48</b>
TB 13	49
TB 18	49
<hr/>	
<b>Built-In Boxes</b>	<b>50</b>
BI 16	51
BI 29 Dual	51
BI 30	52
BI 36	52
BI 40	53
BI 41 Dual	53
BI 53 F	54
BI 75	54
BI 92 Dual	55
BI 172 Dual	55

# Cooling Boxes

## Travel Boxes

### Your reliable partner for daily use and /or in extreme conditions!

No matter where you decide to cruise, Isotherm Travel Boxes offer the right cooling solution for your boat or yacht. The travel box TB 13 and TB 18, thanks to the new BD 1.4F compressor are very compact like thermoelectric fridges but extremely performing.

- Very light and compact design for outdoor conditions
- Reliability: Secop compressor
- Easy to carry, adjustable shoulder strap available for TB 18
- 3 years full warranty and 5 years limited warranty on compressor's mechanical parts (labour excluded)



Optional fixing plate available for TB13



#### Compact and performing: TB 13

- Operating temperature range from +10°C to -18°C
- Easy to use thermostat knob
- DC 12/24V power supply cable for cigarette lighter plug
- Very light and compact design
- Micro compressor technology

#### Inimitable travel mate: TB 18

- Very light and compact design, easy to carry 8.6 kg
- Equipped with NEW BD 1.4F compressor, the smallest and lightest DC unit on the market
- Internal LED light
- Electronic thermostat with easy to use display
- Adjustable shoulder strap

### Product Overview: Travel Boxes

Type	Gross Volume (l)	Dimensions W x H x D (mm)	Weight (kg)	Power consumption (Wh/24h)	Secop compressor type
TB 13 12/24 V DC	13	225 x 360 x 535	11	150	BD1.4F-FSD
TB 18 12/24 V DC	18	453 x 255 x 566	9	150	BD1.4F-VSD

For further details please refer to the master data table.



# Cooling Boxes

## Travel Boxes

13, 18



**TB 13**

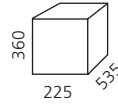

### Isotherm Travel Box 13

Gross Volume (l)	13
Weight (kg)	11
Internal dimensions	290 x 145 x 295

ORDER NUMBER	DESCRIPTION
2013BG1000001	FRIDGE OR FREEZER TRAVEL BOX 13/V



**TB 18**

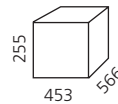

### Isotherm Travel Box 18

Gross Volume (l)	18
Weight (kg)	9
Internal dimensions	260 x 170 x 290

ORDER NUMBER	DESCRIPTION
2018BD1000000	FRIDGE OR FREEZER TRAVEL BOX 18/V

# Cooling Boxes

## Built-In Boxes

Great flexibility during installation, optimal use of on-board space.



- 12/24 V Secop compressor
- Plastic or stainless steel inner lining to prevent any damage even after contact with salt water
- Roller slides available for BI 29 as an option
- Evaporator in foam integrated allows easy cleaning (except BI 40)
- Customizable top

Built-in cooling boxes optimize on-board space thanks to the top-loading access. They are extremely flexible in terms of size and design.

### The advantages of a built-in cooling box:

- Easy access to food and drinks from the top
- Better installation options
- Extremely space saving
- Lid customization options for a perfectly adaptable design

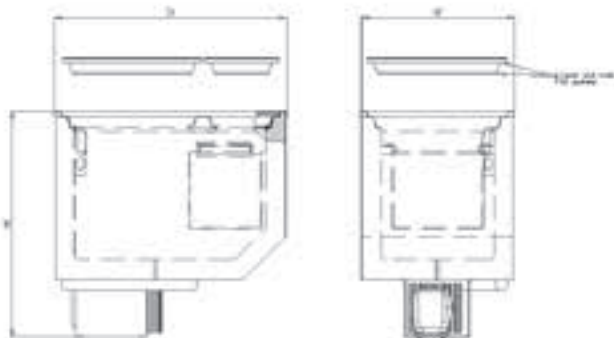

The CRUISE 40 Cubic can also be installed as a built-in top opening cooler box.

### Product Overview: Built-In Cooling Boxes

Type	Gross volume (l)		Dimensions W x H x D (mm) (A - B - D)	Water cooled option	Weight (kg)	Power consumption (Wh/24h)	Secop compressor type	Freezer compartment specifications
	Fridge	Freezer						
BI 16	16		384 x 557 x 240 <sup>(D)</sup>		12	155	BD1.4F-FSD	-
BI 29 Dual*		29	342 x 326 x 655 <sup>(A)(B)</sup>	X	12	175	BD1.4F-AM	± (-6)
BI 29 Dual Custom*		29	342 x 326 x 655 <sup>(A)(B)</sup>	X	11	175	BD1.4F-AM	± (-6)
BI 30	30		449 x 724 x 251 <sup>(B)(D)</sup>		18	254	BD1.4F-FSD	-
BI 36	36		438 x 676 x 240 <sup>(B)(D)</sup>		14	316	BD1.4F-AM	-
BI 40	40		395 x 400 x 560 <sup>(A)(B)</sup>	X	15	270	BD35F	-
BI 41 Dual*		41	342 x 612 x 500 <sup>(B)(D)</sup>	X	14	222	BD1.4F-AM	± (-6)
BI 53 F		53	645 x 630 x 425 <sup>(D)</sup>	X	26	260	BD50F	± ± ± (-18)
BI 75	75		645 x 630 x 425 <sup>(D)</sup>	X	26	340	BD35F	-
BI 92 Dual*		92	801 x 615 x 480 <sup>(D)</sup>	X	28	360	BD50F	± ± ± (-18)
BI 172 Dual	172	38	980 x 840 x 493	X	45	357	BD50F	-
	130					603		± ± (-12)

\* The built-in box operates as a fridge or freezer  
 (A) Depth decreases when removing the compressor  
 (B) Door thickness not included  
 (D) Height decreases when removing the compressor  
 For further details please refer to the master data table

# Cooling Boxes

## Built-In Boxes

### BI 16, BI 29 Dual



#### BI 16

The BI 16 is a top loading refrigerator box, specific for internal application, equipped with the space saving Secop BD Micro compressor solution. The upper lid with inner recess allows big bottles storage. Temperature range 0°C to +10°C.

It combines great usability to high development standards, thanks to its easy to use digital display.

\* Depth only 437 mm when compressor is remote

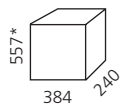

Isotherm Built-In 16	
Weight (Kg)	12
Gross volume (l)	16

ORDER NUMBER	DESCRIPTION
B016TNAAB12111AA	FRIDGE BUILT-IN 16/V



**NEW**

#### BI 29 Dual

BI 29 is a cooling solution characterized by compact design and low weight displacement, thanks to the use of the Secop BD1.4F Micro compressor. The easy to use thermostat allows to operate the product as fridge or freezer, over a range from -20°C to +14 °C. Flexibility in installation is granted through to the custom panel option version and with the compressor being removable up to 0,9 meter away. Equipped with roller slides (optional) the box can be used as a drawer as well.

\* 40 mm door's thickness not included

\*\* Depth only 500 mm when compressor is remote

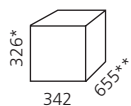

Isotherm Built-In 29 Dual	
Weight (Kg)	12
Gross volume (l)	29

ORDER NUMBER	DESCRIPTION
B029TNBAW17111A1	FRIDGE OR FREEZER BUILT-IN DUAL 29(II)/V

# Cooling Boxes

## Built-In Boxes

### BI 30, BI 36



#### BI 30

The BI 30 is a top loading refrigerator box, specific for internal application, equipped with BD 1.4F FSD by SECOP 12/24V Micro compressor. It has an easy-fix system and a structured casing for the compressor at the bottom. The temperature can be managed thanks to an easy to use digital display. It operates from 0°C to +10°C. The BI 30 combines great usability with high development standards.

\* Height only 604 mm when compressor is remote

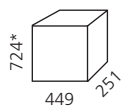

Isotherm Built-In 30	
Weight (Kg)	14
Gross volume (l)	30

ORDER NUMBER	DESCRIPTION
B030TNAAB12111AA	FRIDGE BUILT-IN 30/V



#### BI 36

BI 36 is a top loading refrigerator solution characterized by compact design and low weight displacement, thanks to the use of the Secop BD1.4F Micro compressor. The product is intended to blend into customer's interiors and be customized through the top cover. It operates from 0°C to +16°C and it combines great usability with high development standards.

\* 35 mm door's thickness not included

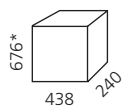

Isotherm Built-In 36	
Weight (Kg)	14
Gross volume (l)	36

ORDER NUMBER	DESCRIPTION
B036WNADP12111AA	FRIDGE BUILT-IN 36(II)/V

# Cooling Boxes

## Built-In Boxes

### BI 40, BI 41 Dual



#### BI 40

The BI 40 is a built-in refrigerator box. It has the L-shaped evaporator and a fan-cooled compressor, mounted on the side, can be removed up to 1.2 meters. Other compressor options as SP or Magnum are also available.

- \* 25 mm door's thickness not included
- \*\* Depth only 435 mm when compressor is remote

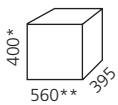

#### Isotherm Built-In 40

Weight (Kg)	15
Gross volume (l)	40

#### ORDER NUMBER

3040BA2A00000

#### DESCRIPTION

FRIDGE BUILT-IN 40/V



**NEW**

#### BI 41 Dual

The BI 41 is a cooling solution characterized by compact design and low weight displacement, thanks to the use of the Secop BD1.4F Micro compressor. The easy to use thermostat device allows to operate the product as fridge or freezer, according to customer's needs. It offers a wide operating range from -22°C to +13°C. The fan-cooled compressor is mounted on the bottom, or can be easily repositioned up to 0.9 meter away. Other compressor options as SP or Magnum are also available. It is made by high quality upper flange and inner cabinet, nice & easy to clean, provided with a practical wire basket perfect for food & drink storage.

- \* 15 mm door's thickness not included
- Height only 451 mm when compressor is remote

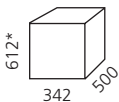

#### Isotherm Built-In 41 Dual

Weight (Kg)	14
Gross volume (l)	41

#### ORDER NUMBER

B041TNAAP17111A1

#### DESCRIPTION

FRIDGE OR FREEZER BUILT-IN 41 DUAL (II)/V

# Cooling Boxes

## Built-In Boxes

### BI 53 F, BI 75



#### BI 53 F

The BI 53 F is a built-in freezer box with stainless steel inner lining, plastic bottom section, a wire basket and an interior light. It offers a temperature range of 0°C to -20°C. The fan-cooled compressor unit is bottom-mounted and can be easily removed up to 1.5 meters. SP or Magnum cooling systems are available as an additional option to air cooling.

\* Height only 510 mm when compressor is remote

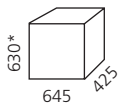

Isotherm Built-In 53 F	
Weight (Kg)	26
Gross volume (l)	53

ORDER NUMBER	DESCRIPTION
3053BC2B00000	FREEZER BUILT-IN INOX 53/V - REMOTE UNIT 2M WITHOUT X-COUPPLINGS



#### BI 75

The BI 75 is a built-in fridge box with stainless steel inner lining, plastic bottom section, a wire basket and an interior light. The fan-cooled compressor unit is bottom-mounted and can be easily removed up to 1.5 meters. SP or Magnum cooling systems are available as an additional option to air cooling.

\* Height only 510 mm when compressor is remote

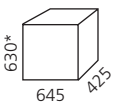

Isotherm Built-In 75	
Weight (Kg)	26
Gross volume (l)	75

ORDER NUMBER	DESCRIPTION
3075BB2B00000	FRIDGE BUILT-IN INOX 53/V

# Cooling Boxes

## Built-In Boxes

### BI 92 Dual, BI 172 Dual



#### BI 92 Dual

The BI 92 is a built-in fridge or freezer box with stainless steel inner lining, plastic bottom section, three wire baskets and an interior light. It offers a temperature range of +10°C to -20°C. The fan-cooled compressor unit is bottom-mounted and can be easily removed up to 1.5 meters. SP or Magnum cooling systems are available as an additional option to air cooling.

\* Height only 492 mm when compressor is remote

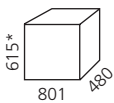

Isotherm Built-In 92 Dual	
Weight (Kg)	28
Gross volume (l)	92

ORDER NUMBER	DESCRIPTION
3092BB2B00000	FRIDGE OR FREEZER BUILT-IN INOX DUAL 92/V - REMOTE UNIT 2M WITHOUT X-COUPPLINGS



#### BI 172 Dual

BI 172 DUAL is a combined cooling solution that brings together a refrigerator-only option with a volume of 172 and a refrigerator/freezer option with a volume of 130 and 38. Modularity is the innovative concept of the BI172. The foamed on the evaporator side can be added or removed according to the desired product function. Top loading openings are for the fridge and freezer compartments while front loading opening is for the fridge compartment. Isotherm Power Pack ready for AC/DC application.

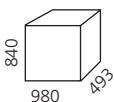

Isotherm Built-In 172 Dual	
Weight (Kg)	45
Gross volume (l)	172

ORDER NUMBER	DESCRIPTION
B172YNAAA14111AA	FRIDGE AND FREEZER BUILT-IN DUAL 172/V

# Master Data Table

## Cruise, Drawer & Built-in

### Product Overview

MODEL	FUNCTION	Gross Volume fridge (l)	Gross Volume freezer (l)	Weight (Kg)	Width (W) (mm)	Height (H) (mm) (A)
CR 36	FRIDGE	36	-	16	440	250
CR 36 INOX	FRIDGE	36	-	17	455	255
CR 40 CUBIC	FRIDGE OR FREEZER	40		18	420	435
CR 42	FRIDGE + FREEZER COMPARTMENT	37	5	14	380	525
CR 42 EL	FRIDGE + FREEZER COMPARTMENT	37	5	14	380	525
CR 42 INOX CLEAN TOUCH	FRIDGE + FREEZER COMPARTMENT	37	5	15	400	525
CR 49	FRIDGE + FREEZER COMPARTMENT	44	5	17	380	525
CR 49 EL	FRIDGE + FREEZER COMPARTMENT	44	5	17	380	525
CR 49 INOX CLEAN TOUCH	FRIDGE + FREEZER COMPARTMENT	44	5	18	400	525
CR 63 F	FREEZER	-	63	23	475	620
CR 63 F INOX	FREEZER	-	63	25	494	623
CR 65	FRIDGE + FREEZER COMPARTMENT	60	5	18	450	530
CR 65 EL	FRIDGE + FREEZER COMPARTMENT	60	5	18	450	530
CR 65 INOX CLEAN TOUCH	FRIDGE + FREEZER COMPARTMENT	60	5	19	470	530
CR 65 F	FREEZER	-	65	25	525	610
CR 65 F INOX	FREEZER	-	65	27	544	610
CR 85	FRIDGE + FREEZER COMPARTMENT	77	8	22	475	627
CR 85 EL	FRIDGE + FREEZER COMPARTMENT	77	8	22	475	627
CR 85 INOX CLEAN TOUCH	FRIDGE + FREEZER COMPARTMENT	77	8	24	495	627
CR 86	FRIDGE + FREEZER COMPARTMENT	76	10	22	380	850
CR 90 F	FREEZER	-	90	26	525	750
CR 90 F INOX CLEAN TOUCH	FREEZER	-	90	28	545	750
CR 100	FRIDGE + FREEZER COMPARTMENT	94	6	23	486	745
CR 130	FRIDGE + FREEZER COMPARTMENT	122	8	27	525	750
CR 130 EL	FRIDGE + FREEZER COMPARTMENT	122	8	27	525	750
CR 130 INOX CLEAN TOUCH	FRIDGE + FREEZER COMPARTMENT	122	8	29	545	750
CR 130 INOX CLEAN TOUCH SPECIALE	FRIDGE + FREEZER COMPARTMENT	122	8	31	545	794
CR 130 DRINK	FRIDGE	130	-	27	527	750
CR 130 DRINK INOX	FRIDGE	130	-	32	544	750
CR 160 DRINK INOX	FRIDGE	160	-	45	626	870
CR 195 COMBI	FRIDGE & FREEZER	130	65	54	551	1347
CR 195 COMBI INOX	FRIDGE & FREEZER	130	65	54	544	1347
CR 200	FRIDGE & FREEZER	150	50	47	731	880
CR 200 INOX	FRIDGE & FREEZER	150	50	48	731	880
CR 220 COMBI INOX	FRIDGE & FREEZER	130	90	61	544	1545
CR 225 SILVER	FRIDGE & FREEZER	180	45	36	547	1444
CR 260 COMBI INOX	FRIDGE + FREEZER COMPARTMENT	244	16	64	544	1545
CR 280 SILVER	FRIDGE & FREEZER	235	45	41	547	1700
CR 320 COMBI INOX	FRIDGE	320	-	84	628	1790
CR 320 COMBI INOX	FRIDGE & FREEZER	250	70	87	628	1790
CR 320 COMBI INOX	FRIDGE & FREEZER	160	160	86	628	1790
FL 115 EL	FRIDGE + FREEZER COMPARTMENT	83	32	29	525	797



Depth (D) (mm) (A)	Cut-Out (mm)	Flanges (B)	Freezer rating (max temp. °C)	Climatic class	Compressor type	Power supply (V)	Power consumption (Wh/24h)
685 <sup>(0)</sup>	442:252	3 side FM SS <sup>(VII)</sup>	-	ST	BD35F	12/24V	300
715	457:257	4 side FM SS <sup>(VII)</sup>	-	ST	BD35F	12/24V	300
585 <sup>(0)</sup>	422:437	NO	■ ■ (-12)	ST	BD35F	12/24V	186
455 <sup>(0)</sup>	382:527	OPT	■ (-6)	ST	BD1.4F-VSD	12/24V	300
455 <sup>(0)</sup>	382:527	OPT	■ (-6)	ST	BD1.4F-VSD	12/24V	285
500	402:527	3 side FM SS <sup>(VII)</sup>	■ (-6)	ST	BD1.4F-VSD	12/24V	285
452 <sup>(0)</sup>	382:527	OPT	■ (-6)	ST	BD35F	12/24V	278
452 <sup>(0)</sup>	382:527	OPT	■ (-6)	ST	BD35F	12/24V	265
500	402:527	3 side FM SS <sup>(VII)</sup>	■ (-6)	ST	BD35F	12/24V	265
513 <sup>(0)</sup>	477:622	OPT	■ ■ ■ (-18)	ST	BD35F	12/24V	440
552	496:625	3 side FM SS* <sup>(VII)</sup>	■ ■ ■ (-18)	ST	BD35F	12/24V	440
473 <sup>(0)</sup>	452:532	OPT	■ (-6)	ST	BD35F	12/24V	288
473 <sup>(0)</sup>	452:532	OPT	■ (-6)	ST	BD35F	12/24V	275
520	472:532	3 side FM SS <sup>(VII)</sup>	■ (-6)	ST	BD35F	12/24V	275
540 <sup>(0)</sup>	527:612	NO	■ ■ ■ (-18)	ST	BD35F	12/24V	458
580	546:612	3 side FM SS <sup>(VII)</sup>	■ ■ ■ (-18)	ST	BD35F	12/24V	458
505 <sup>(0)</sup>	477:629	OPT	■ (-6)	ST	BD35F	12/24V	386
505 <sup>(0)</sup>	477:629	OPT	■ (-6)	ST	BD35F	12/24V	368
550	497:629	3 side FM SS <sup>(VII)</sup>	■ (-6)	ST	BD35F	12/24V	368
495 <sup>(0)</sup>	382:852	OPT	■ (-6)	ST	BD1.4F-VSD	12/24V	499
515 <sup>(0)</sup>	527:752	OPT	■ ■ (-12)	ST	BD35F	12/24V	670
565	547:752	3 side FM SS <sup>(VII)</sup>	■ ■ (-12)	ST	BD35F	12/24V	626
455 <sup>(0)</sup>	488:747	OPT	■ (-6)	ST	BD35F	12/24V	400
510 <sup>(0)</sup>	527:752	OPT	■ (-6)	ST	BD35F	12/24V	438
510 <sup>(0)</sup>	527:752	OPT	■ (-6)	ST	BD35F	12/24V	418
555	550:750	3 side FM SS <sup>(VII)</sup>	■ (-6)	ST	BD35F	12/24V	418
585	552:796	3 side FM SS <sup>(VII)</sup>	■ (-6)	ST	BD35F	12/24V	418
520 <sup>(0)</sup>	529:752	OPT	-	ST	BD35F	12/24V	400
560	546:752	3 side FM SS <sup>(VII)</sup>	-	ST	BD35F	12/24V	400
610	628:872	3 side FM SS <sup>(VII)</sup>	-	ST	BD50F	12/24V	512
565	553:1349	3 side FM <sup>(IX)</sup>	■ ■ ■ (-18)	ST	2 x BD35F	12/24V	840
565	546:1349	3 side FM SS <sup>(VII)</sup>	■ ■ ■ (-18)	ST	2 x BD35F	12/24V	840
620	732:882	3 side FM SS <sup>(VII)</sup>	■ ■ (-12)	ST	BD50F	12/24V	874
620	732:882	3 side FM SS <sup>(VII)</sup>	■ ■ (-12)	ST	BD50F	12/24V	874
560	546:1547	3 side FM SS <sup>(VII)</sup>	■ ■ (-12)	ST	2 x BD35F	12/24V	1070
486 <sup>(IV)</sup>	549:1446	NO	■ ■ ■ (-18)	ST	BD50F	12/24V	630
560	546:1547	3 side FM SS <sup>(VII)</sup>	■ (-6)	ST	2 x BD35F	12/24V	836
486 <sup>(IV)</sup>	549:1702	NO	■ ■ ■ (-18)	ST	BD50F	12/24V	680
610	630:1792	3 side FM SS <sup>(VII)</sup>	-	ST	2 x BD50F	12/24V	1042
610	630:1792	3 side FM SS <sup>(VII)</sup>	■ (-6)	ST	BD50F + BD80F	12/24V	1147
610	630:1792	3 side FM SS <sup>(VII)</sup>	■ ■ (-12)	ST	BD50F + BD80F	12/24V	1609
495 <sup>(0)</sup>	527:799	NO	■ (-6)	ST	BD35F	12/24V	257

MODEL	FUNCTION	Gross Volume fridge (l)	Gross Volume freezer (l)	Weight (Kg)	Width (W) (mm)	Height (H) (mm) (A)
DR 16	FRIDGE OR FREEZER	16		13	380	250
DR 30	FRIDGE	30	-	17	440	260
DR 42 INOX CLEAN TOUCH	FRIDGE + FREEZER COMPARTMENT	34	8	18	399	519
DR 49 INOX CLEAN TOUCH	FRIDGE + FREEZER COMPARTMENT	41	8	18	399	519
DR 49 CUSTOM (der. INOX CLEAN TOUCH)	FRIDGE + FREEZER COMPARTMENT	41	8	17	379	519
DR 55 FROST FREE INOX	FREEZER	-	55	27	469	525
DR 55 FROST FREE CUSTOM	FREEZER	-	55	25	457	525
DR 65 INOX CLEAN TOUCH	FRIDGE + FREEZER COMPARTMENT	54	11	21	470	525
DR 65 CUSTOM (der. INOX CLEAN TOUCH)	FRIDGE + FREEZER COMPARTMENT	54	11	19	452	525
DR 65 FROST FREE INOX	FRIDGE	65	-	26	469	525
DR 65 INOX FROST FREE DRINK	FRIDGE	65	-	27	469	525
DR 65 FROST FREE CUSTOM	FRIDGE	65	-	25	457	525
DR 70 INOX CLEAN TOUCH	FRIDGE	70	-	31	626	444
DR 70 CUSTOM	FRIDGE	70	-	29	611	444
DR 70 INOX CLEAN TOUCH	FREEZER	-	70	32	627	444
DR 70 CUSTOM	FREEZER	-	70	30	611	444
DR 70 INOX CLEAN TOUCH ver. 230V 50Hz	FREEZER + ICEMAKER	-	60	38	627	444
DR 70 INOX CLEAN TOUCH ver. 115V 60Hz	FREEZER + ICEMAKER	-	60	38	627	444
DR 70 CUSTOM ver. 230V 50Hz	FREEZER + ICEMAKER	-	60	36	611	444
DR 70 CUSTOM ver. 115V 60Hz	FREEZER + ICEMAKER	-	60	36	611	444
DR 85 INOX CLEAN TOUCH	FRIDGE + FREEZER COMPARTMENT	88	13	23	494	619
DR 85 CUSTOM	FRIDGE + FREEZER COMPARTMENT	88	13	N/A	N/A	N/A
DR 100 INOX CLEAN TOUCH	FRIDGE	100	-	32	546	501
DR 100 CUSTOM	FRIDGE	100	-	30	529	501
DR 100 INOX CLEAN TOUCH	FREEZER	-	100	33	546	501
DR 100 CUSTOM	FREEZER	-	100	31	529	501
DR 100 INOX CLEAN TOUCH ver. 230V 50Hz	FREEZER + ICEMAKER	-	90	39	546	501
DR 100 INOX CLEAN TOUCH ver. 115V 60Hz	FREEZER + ICEMAKER	-	90	39	546	501
DR 100 CUSTOM ver. 230V 50Hz	FREEZER + ICEMAKER	-	90	39	529	501
DR 100 CUSTOM ver. 115V 60Hz	FREEZER + ICEMAKER	-	90	39	529	501
DR 105 INOX	FRIDGE	105	-	28	515	515
DR 130 INOX CLEAN TOUCH	FRIDGE + FREEZER COMPARTMENT	124	14	27	544	744
DR 130 CUSTOM	FRIDGE + FREEZER COMPARTMENT	124	14	N/A	N/A	N/A
DR 160 INOX	FRIDGE	160	-	43	627	865
DR 160 CUSTOM	FRIDGE	160	-	41	613	868
DR 160 INOX	FREEZER	-	160	45	627	865
DR 160 CUSTOM	FREEZER	-	160	43	613	868
DR 160 INOX	FRIDGE & FREEZER	90	70	46	627	865
DR 160 CUSTOM	FRIDGE & FREEZER	90	70	44	613	868
DR 190 INOX	FRIDGE	190	-	56	900	800
DR 190 CUSTOM	FRIDGE	190	-	53	898	798
BI 16	FRIDGE	16	-	12	384	557
BI 29 DUAL	FRIDGE OR FREEZER	29		12	342	326 <sup>(I)</sup>
BI 29 DUAL CUSTOM	FRIDGE OR FREEZER	29		11	342	326 <sup>(VI)</sup>
BI 30	FRIDGE	30	-	16	449	724
BI 36	FRIDGE	36	-	14	438	676 <sup>(III)</sup>
BI 40	FRIDGE	40	-	15	395	400 <sup>(V)</sup>
BI 41 DUAL	FRIDGE OR FREEZER	41		14	342	612 <sup>(VI)</sup>
BI 53 F	FREEZER	-	53	20	645	630
BI 75	FRIDGE	75	-	23	645	630
BI 92 DUAL	FRIDGE OR FREEZER	92		31	801	615
BI 172 DUAL	FRIDGE & FREEZER	130 (172 if only fridge)	38	38	980	840

**A. Door dimension to be added**

- (I) add 40mm for door depth
- (II) add 50mm for door depth
- (III) add 35mm for door depth

- (IV) add 70mm for door depth
- (V) add 25mm for door dimension
- (VI) add 15mm for door dimension

**B. Width of flanges**

- (VII) 20mm
- (VIII) 30mm.
- (IX) 38 sides width and 28 top height
- (X) 20 mm sides and 50 mm top height

Depth (D) (mm) (A)	Cut-Out (mm)	Flanges (B)	Freezer rating (max temp. °C)	Climatic class	Compressor type	Power supply (V)	Power consumption (Wh/24h)
540	382:252	OPT	■ (-6)	ST	BD1.4F-FSD	12/24V	252
700	442:262	OPT	-	T	BD1.4F-FSD	12/24V	244
511	401:521	3 side FM SS <sup>(VI)</sup>	■ (-6)	ST	BD1.4F-VSD	12/24V	333
497	401:521	3 side FM SS <sup>(VI)</sup>	■ (-6)	ST	BD1.4F-VSD	12/24V	305
494	381:521	NO	■ (-6)	ST	BD1.4F-VSD	12/24V	305
555	471:527	3 side FM SS <sup>(VI)</sup>	■■ (-12)	N	BD35F	12/24V	741
560	459:527	NO	■■ (-12)	N	BD35F	12/24V	741
520	474:529	3 side FM SS <sup>(VI)</sup>	■ (-6)	ST	BD1.4F-VSD	12/24V	324
525	456:529	NO	■ (-6)	ST	BD1.4F-VSD	12/24V	324
555	471:527	3 side FM SS <sup>(VI)</sup>	-	ST	BD35F	12/24V	310
555	471:527	4 side FM SS(I)	-	ST	BD35F	12/24V	310
560	459:527	NO	-	ST	BD35F	12/24V	310
724	631:448	3 side FM SS <sup>(VI)</sup>	-	T	BD35F	12/24V	295
726	615:448	NO	-	T	BD35F	12/24V	295
724	631:448	3 side FM SS <sup>(VI)</sup>	■■ (-12)	T	BD50F	12/24V	800
726	615:448	NO	■■ (-12)	T	BD50F	12/24V	800
786	631:448	3 side FM SS <sup>(VI)</sup>	■■ (-12)	T	TLESS.7FT.3	230V	1055
786	631:448	3 side FM SS <sup>(VI)</sup>	■■ (-12)	T	TLS4.5F	115V	1380
788	615:448	NO	■■ (-12)	T	TLESS.7FT.3	230V	1055
788	615:448	NO	■■ (-12)	T	TLS4.5F	115V	1380
544	N/A	3 side FM SS <sup>(VI)</sup>	■■ (-12)	T	BDN45F	12/24V	300
N/A	N/A	NO	N/A	N/A	BDN45F	12/24V	300
778	550:505	3 side FM SS <sup>(I)</sup>	-	T	BD35F	12/24V	252
779	533:505	3 side FM SS <sup>(VI)</sup>	-	T	BD35F	12/24V	252
778	550:505	3 side FM SS <sup>(VI)</sup>	■■ (-12)	T	BD50F	12/24V	503
779	533:505	3 side FM SS <sup>(VI)</sup>	■■ (-12)	T	BD50F	12/24V	503
840	550:505	3 side FM SS <sup>(VI)</sup>	■■ (-12)	T	TLESS.7FT.3	230V	790
840	550:505	3 side FM SS <sup>(VI)</sup>	■■ (-12)	T	TLS4.5F	115V	1031
841	533:505	3 side FM SS <sup>(VI)</sup>	■■ (-12)	T	TLESS.7FT.3	230V	790
841	533:505	3 side FM SS <sup>(VI)</sup>	■■ (-12)	T	TLS4.5F	115V	1031
575+170*	519:517	NO	-	ST	BD35F	12/24V	480
551	N/A	3 side FM SS <sup>(VI)</sup>	N/A	N/A	BDN45F	12/24V	N/A
N/A	N/A	NO	N/A	N/A	BDN45F	12/24V	N/A
610	632:870	3 side FM SS <sup>(VI)</sup>	-	ST	BD50F	12/24V	530
622	617:872	NO	-	ST	BD50F	12/24V	530
610	632:870	3 side FM SS <sup>(VI)</sup>	■■ (-12)	ST	BD80F	12/24V	1097
622	617:872	NO	■■ (-12)	ST	BD80F	12/24V	1097
610	632:870	3 side FM SS <sup>(VI)</sup>	■ (-6)	ST	BD80F	12/24V	635
622	617:872	NO	■ (-6)	ST	BD80F	12/24V	635
545	905:805	3 side FM SS <sup>(VI)</sup>	-	ST	BD50F	12/24V	700
551	902:802	NO	-	ST	BD50F	12/24V	700
240	384:242	NO	-	ST	BD1.4F-FSD	12/24V	155
655	344:505	NO	■ (-6)	T	BD1.4F-AM	12/24V	175
655	344:505	NO	■ (-6)	T	BD1.4F-AM	12/24V	175
251	453:255	NO	-	T	BD1.4F-FSD	12/24V	254
240	440:242	NO	-	T	BD1.4F-AM	12/24V	316
560	405:405	NO	-	ST	BD35F	12/24V	270
500	502:344	NO	■ (-6)	ST	BD1.4F-AM	12/24V	222
425	649:429	NO	■■ (-18)	ST	BD50F	12/24V	260
425	649:429	NO	-	ST	BD35F	12/24V	340
480	805:484	NO	■■ (-18)	ST	BD50F	12/24V	360
493	984:497	NO	■■ (-12)	ST	BD50F	12/24V	603 (357 if only fridge)

**NOTE:**

- 1) Refrigerators manufacturing tolerances -2/+4 mm
- 2) Dimensions include product's feet
- 3) Isotherm Power Pack available for AC/DC application on all 12/24V products
- 4) For all 12/24 V products, power consumption Wh/24h in operation on 12 V and ambient temperature +25°C

- according to the Standards ISO 15502:2005 and EN 153:2006
- 5) Most of Isotherm fridges can also benefit from a retrofitted Isotherm Smart Energy Control or Intelligent Temperature Control kit. On some models it reduces battery consumption up to 50 %
  - 6) According to EN 603335 - 1 regulation, the inside walls

- of the furniture housing the refrigerator must be distant from the fridge by 20 mm per side and 50 mm from the top. Please refer to the installation manual for further technical / installation details
- 7) Specification changes may be made without prior notice
  - \* Product sold already with remote compressor



## Isotherm Exclusive Cooling Technology

Energy is a precious resource on board of any boat or yacht. Indel Webasto Marine continuously improves its energy management solutions to provide better efficiency and clever power saving for customers.

# Cooling Technology

<b>Isotherm Intelligent Temperature Control</b>	<b>62</b>
<hr/>	
<b>Isotherm Smart Energy Control</b>	<b>63</b>
<hr/>	
<b>Frost-free</b>	<b>64</b>
<hr/>	

# Cooling Technology

## Isotherm Intelligent Temperature Control

### Isotherm ITC Digital display



The ITC Digital Display clearly shows, controls and regulates temperature in a refrigerated compartment from the exterior of a fridge/freezer cabinet. ITC is the ideal solution for those who want to integrate onboard power consumption with a nice-looking interface and a refined product interaction. An air sensor in the cabinet allows the electronic control unit to detect the air temperature and operate accordingly to the selected settings. Interaction with the product remotely makes it easy to read the data on the display. The display allows monitoring the temperature detected and enables to select various parameters

such as the temperature set, the energy saving operations, the choice of 3 battery protection levels and compressor's operation mode settings (ITC, Eco and Overcooling mode). Product integration is simple, since the device is compatible with control units Indel Webasto Marine P/N SEG00002DA and SEG00030GA (respectively Secop versions 101N0212 and 101N0510 for BD35/50F) allowing a recess flush installation and a wall mounted.

#### **ITC+, The unbeatable combination.**

ITC+ is the integration of the ITC with the Isotherm holding plates, combining the benefits of the ITC system with the energy storage effect.



#### **Convincing factors are:**

- Available as retrofit kit or originally fitted on fridges in the factory
- Up to 25% energy saving due to a more efficient use of the compressor
- Up to 40% savings with combined effects of stored cooling energy in food and drinks
- Quick cooling in boost mode
- Soft start to avoid starting peaks
- Eco mode
- Easy to set battery protection directly from the display

# Cooling Technology

## Smart Energy Control

### Isotherm Smart Energy Control



Isotherm Smart Energy Control is a cooling technology performed to improve the energy-saving capabilities of our isotherm cooling units.

#### How does it work?

The sophisticated, processor-based Isotherm Smart Energy Control technology achieves significant savings in power consumption by continuously scanning a set of key environmental factors to determine, through advanced proprietary algorithms, which compressor speed is best suited to maximize the performance/battery drain ratio (COP).



A dedicated air sensor which can continuously measure the cabinet air temperature.



Potentiometer to activate the Isotherm Smart Energy Control mode.



Processor-based module to be connected to the Secop compressor.

The SEC Kit consists of a dedicated air sensor to detect the air temperature in the cabinet, a potentiometer and a processor-based module. Isotherm Smart Energy Control allows cold energy to be stored in food and drinks placed inside the refrigerator, reducing the cabinet temperature more than a conventional fridge, without freezing foods. When a surplus energy is available (engine on or connection to grid), the cooling energy is stored and reused before the fridge runs on battery power.

#### The result: Significant energy savings.

##### External factors

- Cabinet air temperature
- Temperature set point
- Battery charge status
- Battery voltage

##### Configuration Parameters

- Cabinet size
- Offset values

##### Available potential of DC fridges

- Energy storage potential of loaded food/drinks
- Variable speed capability of DC compressors



##### Energy Savings

- Maximized performance/battery drain ratio (COP)
- Reuse of energy stored in food/drinks
- Speed modulation: Soft start up and boost mode

#### Multiple benefits from a simple kit:

- Up to 35 % savings due to a more efficient use of the compressor
- Up to 50 % savings with combined effects of stored cooling energy in food and drinks
- No need for eutectic plates/special storage devices
- Easy to retrofit
- Quick cooling in boost mode
- Soft start to avoid starting peaks



# Cooling Technology

## Frost-free technology



### **Frost-free – Award winning technology**

The Indel Webasto Marine Frost-free concept is based on an intelligent principle that prevents the accumulation of ice inside the freezer thus keeping energy consumption low. All models equipped with the Frost-free concept are extremely economical and save energy on board.

### **The advantages of the Frost-free concept:**

- Indel Webasto Marine exclusive technology for the marine market
- No ice buildup for excellent efficiency gains
- Exceptional cooling result: the refrigerator and the freezer reach the set temperature faster
- Stable internal temperature
- Manual defrosting becomes redundant
- No more unpleasant water puddles caused by incorrect manual defrosting









Photo courtesy of Jérôme Kelagopian

## Isotherm Cooling Units

Indel Webasto Marine provides different solutions to cool at best some custom volumes using air or seawater for efficient heat removal.

# Cooling Units

Isotherm Cooling Units	68
<hr/>	
Core Components	70
<hr/>	
Control Devices	71
<hr/>	
ITC+	72
<hr/>	
<b>Cooling System</b>	<b>74</b>
Air-cooled	78
Water-cooled SP	86
Water-cooled Magnum	88
<hr/>	
Cooling Unit ITC+	91
<hr/>	

# Isotherm Cooling Units

An innovative modular concept

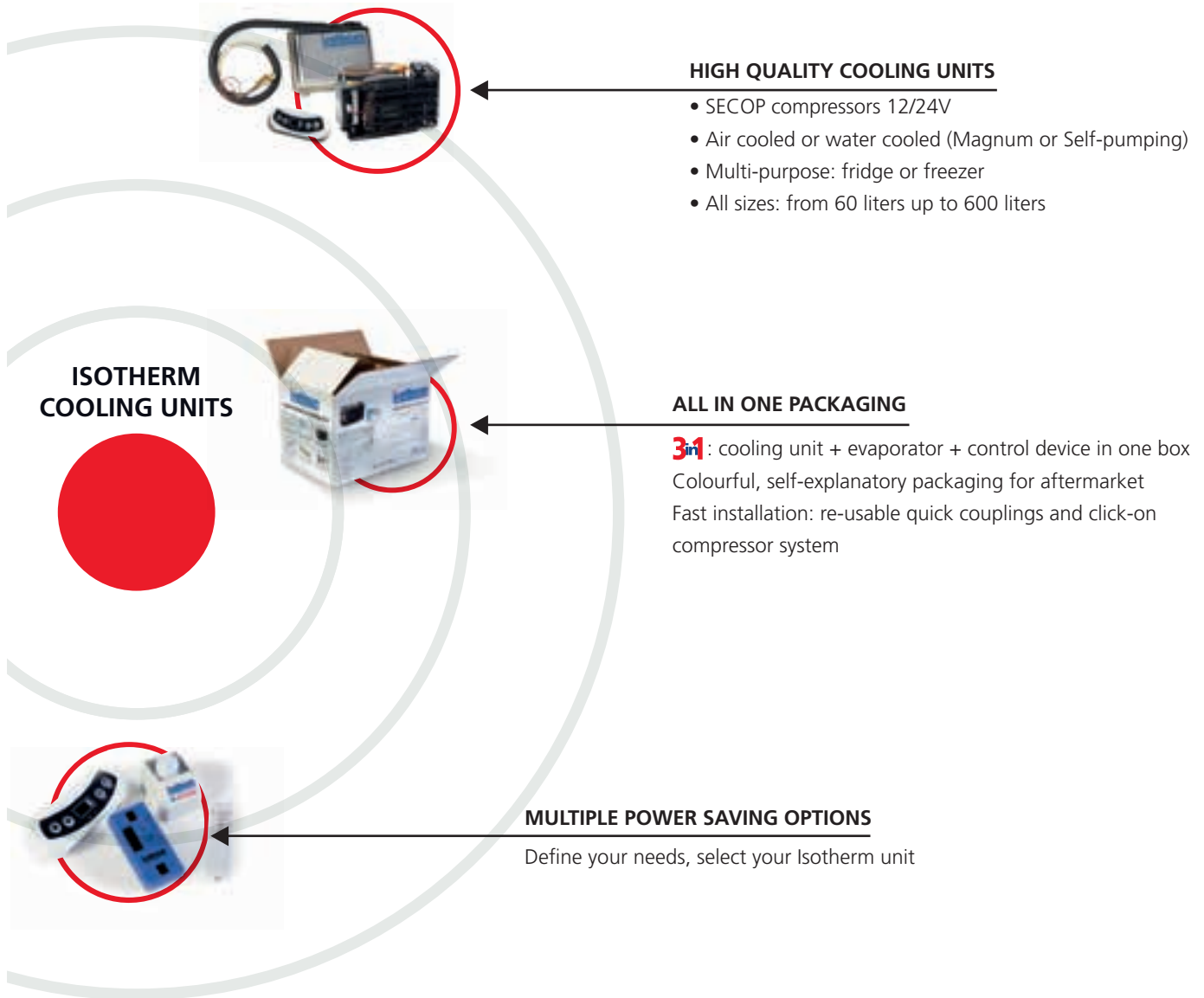

## SELECTION MATRIX

Type	Control Interface	Energy Saving	Fast Cooling	Functions
Isotherm	Mechanical	0	++	
ITC	Digital	++	++	1. Dynamic control of battery charging status 2. Standard energy savings (overcooling, fixed compressor speeds) 3. Eco mode to extend battery autonomy 4. AC and/or DC applications possible
ITC+	Digital	+++	+	
SEC	Electronic	++++	+++	1. Full modulation of compressor speed 2. Advanced parameter settings to maximize energy savings 3. High energy savings without need for cold storage device 4. DC application only

# Isotherm Cooling Units

Ready to meet any demand

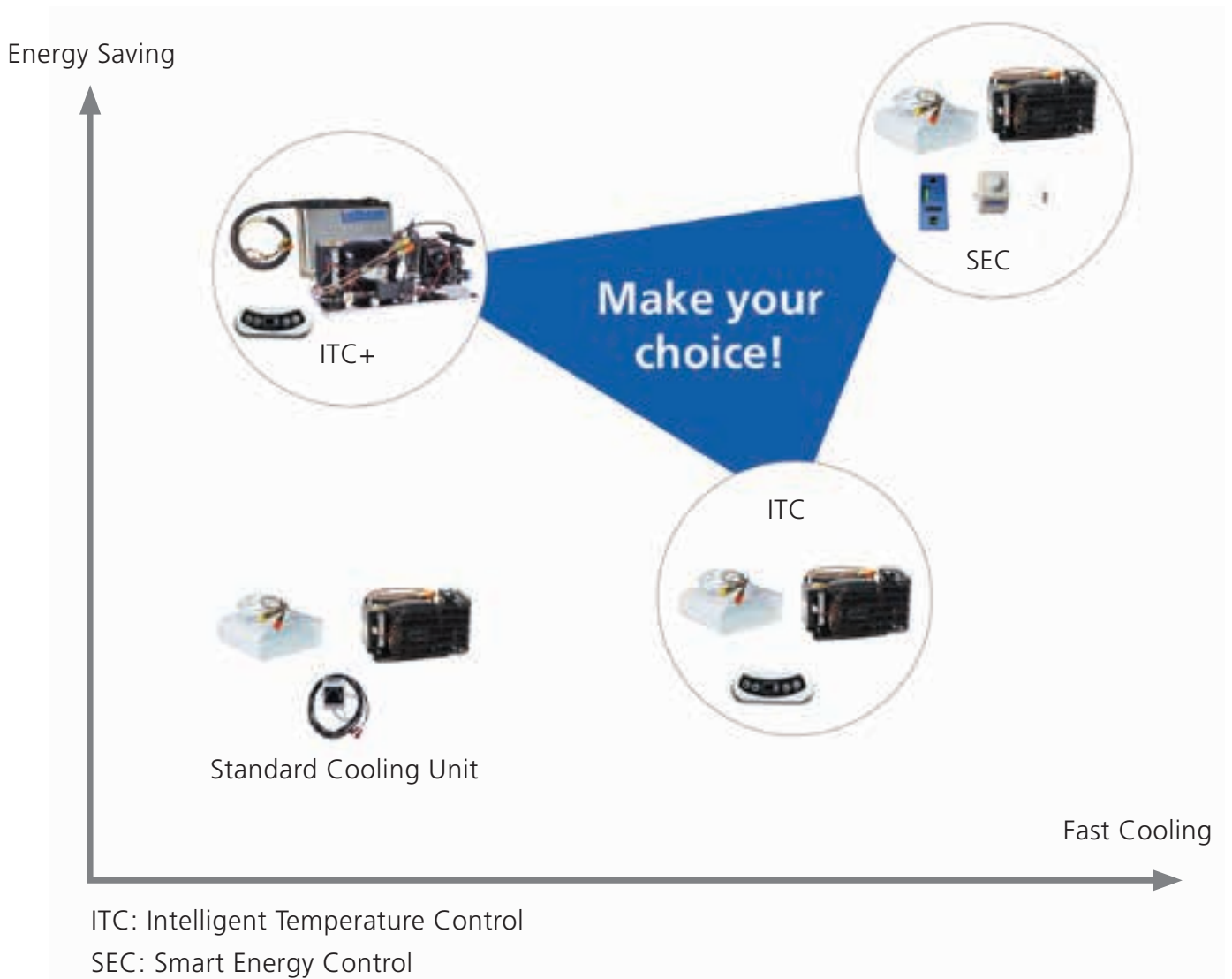

# Isotherm Cooling Units

## Core Components

### The best and widest product range available on the market!

Indel Webasto offers the most technologically advanced and complete selection of cooling unit components available on the market. High flexibility in product customization meets any demand and cooling units range from 60 to 600 liters fridge capacity or from 20 to 200 liters freezer capacity. Free up your layouts and get the most of your on-board space with Isotherm cooling units!

Secop compressors are now even more power efficient! Hermetically sealed, extremely quiet running and reliable they are specifically developed for Isotherm applications. The three-phase current is inverted in a small microprocessor that checks and controls the functions of the compressor allowing the lowest possible power consumption.

The same compressor is used both for 12V and 24V systems and the electronic unit is able to protect itself from accidental reversal of the voltage polarity. Isotherm Power Pack is available for AC/DC application to allow sufficient short power use. A wide range of evaporators, exclusive Isotherm know-how, allow an unbeatable product performance and flexible on

board application. The variety of controls meets any customer demands and guarantees the lowest power consumption on the market.

**Feel free to select the best way to dissipate heat according to the constraints of the application, by air or water cooling. Finally choose the best control system based on your application needs, with the unique plus of being delivered with a self-explanatory all-in-one packaging! (Only for premium products as SEC, ITC and ITC+).**



### Re-Usable Quick couplings

All cooling units are equipped with the new type of quick couplings that can be disconnected without any gas leakage like the former versions.

In addition the valve assembly inside the coupling's body can be easily replaced, without welding operations.



### Practical click-on mounting bracket

A practical click-on mounting bracket, suitable for horizontal or vertical wall installation, is included in all models except Magnum models.

Fasten the bracket and lift the compressor into place.

„Click“! The compressor locks onto the bracket without the need for adjustments or tools.



# Isotherm Cooling Units

## Control Devices

---



The mechanical thermostat represents the standard control device of the cooling unit program being reliable and easy to use for boat owners. It allows a fast cooling process of the compartment by managing compressor activation on a basic on/off command.

The ITC Digital Display (Intelligent Temperature Control) clearly shows, controls and regulates the temperature of a fridge/freezer cabinet thanks to the dedicated air sensor that provides accurate readings on display. The digital display allows the end user to select specific factory settings (ITC, Eco and overcooling mode) and different levels of battery protection while reducing on-board power consumption.

It is the ideal solution for people who want a nice looking interface and a professional product interaction.

The ITC Digital Display, together with a Holding Plate, forms a cooling unit called ITC+, where the storing energy effect is amplified due to the wide range of plates available.



The Smart Energy Control (SEC) is a sophisticated processor-based control device that significantly reduces power consumption by continuously scanning a set of key environmental factors that enables the compressors to achieve best performance/battery drain ratio. Thanks to the cold retention capacity of food and drinks, SEC can save up to 50% compared to conventional control systems, representing the best answers for users seeking the lowest power consumption.

# Isotherm Cooling Units

## ITC+

ITC+ technology represents the best solution in cooling performances and temperature control, as the typical features of the ITC digital panel are enhanced by the storage energy effect of the eutectic plate.

When a surplus of power is detected by the air sensor, the cooling plate is frozen to keep cold for a long time.

That's why ITC+ technology provides high-energy savings as the temperature is maintained even when there is no power and the compressor does not run.

ITC+ consists of an unbeatable combination of a high-quality Secop compressor, the ITC electronic control system and the Isotherm holding plate.

Most people want to know how much power is needed. The energy consumption figures of our range of refrigerators, freezers and boxes are the result of testing and knowledge about the size and quality of insulation.

Self-installed refrigeration box, cannot be exactly calculated because of to the lack of important information such as the quality and the thickness of the insulation material used.



### ITC+

The holding plate is charge while the engine is running thanks to the patented energy management system.

## Cooling systems with ITC+

### Air-cooled system



- Low power consumption
- Digital interface with accurate display of temperature
- Fridge or freezer (-12°C)
- 12/24 V Secop compressor
- Isotherm Power Pack available for AC/DC application
- Easy installation thanks to "click-on" system

### Self-pumping cooling system



- Low power consumption
- Digital interface with accurate display of temperature
- Fridge or freezer (-12°C)
- 12/24 V Secop compressor
- Isotherm Power Pack available for AC/DC application
- Easy installation thanks to "click-on" system
- SP system (patented) to reduce noise of standard fan cooled condenser systems

### Magnum cooling system



- Low power consumption
- Digital interface with accurate display of temperature
- Fridge or freezer (-12°C)
- 12/24 V Secop compressor
- Isotherm Power Pack available for AC/DC application
- Self-priming seawater pump (variable speed) to ensure extra high efficiency for tropical applications





# Isotherm Cooling Units

## Cooling systems

### Three possible cooling systems

Indel Webasto Marine provides a wide range of cooling units to suit every demand. For efficient heat removal various methods can be applied. Isotherm cooling units use air or seawater to eliminate the heat.



#### Self-pumping sea water-cooled

Isotherm SP units cool using seawater with the benefit of having heat exchange through a water-cooled condenser. Water-cooled SP systems achieve high performance, consume less battery power and it's remarkably quiet due to the absence of fans and pumps to remove heat generated by the condenser.

The Isotherm SP unit takes advantage of the wavelike movements of the hull to remove heat through a special fitting in the galley sink drain hose.

The "pumping" allows a continuous exchange of water between the outside and the condenser due to the location of the hull connection located away from the gravity point of the boat, sufficient to create a pumping action. The constant warm water outlet and cold water inlet also prevents scaling and an equal exchange of water level in and out.

An extremely efficient cooling system was created by designing a special hull fitting containing a non-restricting, full-flow spiral heat exchanger.

- Fridge or freezer version available
- 12/24 V Secop compressor
- Isotherm Power Pack available for AC/DC application
- Easy installation thanks to "click-on" system on DC models
- SP system (patented) to reduce the noise of a ventilated condenser and reach a lower power consumption



- Sea water cooling for even higher efficiency
- Lower power consumption
- Silent – no fan nor pumps
- Heat removed by sea water (max. temperature 28°C)
- No extra holes in hull required
- Easy to install, it replaces the through-hull fitting for galley sink



### Air-cooling

Isotherm air-cooled units use a fan to circulate air over a condenser to remove heat. The compressor compartment must be well ventilated to allow cold air to enter from below and warm air to exit from above.



- Fridge or freezer versions available
- 12/24 V Secop compressor
- Isotherm Power Pack available for AC/DC application
- Easy installation thanks to "click-on" system on DC models



### Isotherm Magnum – Seawater cooled electric pump

Isotherm Magnum units are specially designed for vessels with exceptionally high refrigeration requirements, for example vessels sailing in tropical waters. All Magnum models use sea water to increase the cooling efficiency through a built-in pump that forces water through the condenser. When the water gets over 28°C the voltage reducer gives the pump extra power to run faster and still achieve the same cooling capacity. The pump is quiet, self-priming, withstands dry running and is self-aerating. The highly efficient heat exchanger is manufactured in a corrosion-resistant copper-nickel alloy and fitted with a zinc anode. Sea water-cooled units are extremely efficient and offer increased cooling capacity.

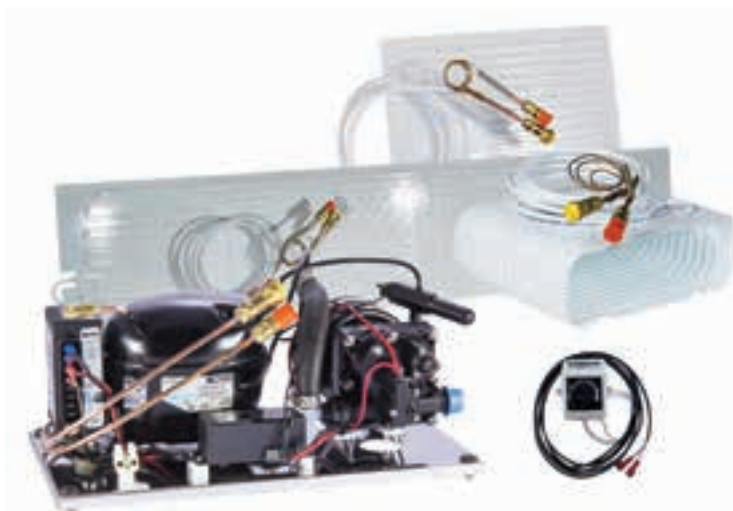

- Fridge or freezer version available
- 12/24 V Secop compressor
- Isotherm Power Pack available for AC/DC application
- Self-priming sea water pump to ensure extra high efficiency for tropical applications
- Variable speed water pump according to the temperature of the water circulating inside the condenser

# Isotherm Cooling Units

## Fridge, Freezer, Fridge/Freezer

### Technical Data:

System	Unit code	Max Volume (l)		Dimensions evaporator (mm)	Dimensions compressor W x H x D (mm)	Weight (kg)	Secop Compressor type	Control
		Fridge	Freezer					
<b>Fridge</b>								
Air-cooled	U060X000P11111AA	60	-	"Flat" 350 x 130	280 x 160 x 175	9	BD35F	Mechanical
Air-cooled	U080X000P11111AA	80	-	"Flat" 350x250	280 x 160 x 175	9	BD35F	Mechanical
Air-cooled	U100X000L11111AA	100	-	"L" 250 + 110 x 350	280 x 160 x 175	12	BD35F	Mechanical
Water-cooled SP	U100X000L11311AA	100	-	"L" 250 + 110 x 350	280 x 160 x 175	14	BD35F	Mechanical
Air-cooled	U100X000L11111AC	100	-	"L" 270 + 95 x 250	280 x 160 x 175	10	BD35F	Mechanical
Air-cooled	U125X000L11111AA	125	-	"L" 400 + 170 x 210	280 x 160 x 175	9	BD35F	Mechanical
Water-cooled SP	U125X000L11311AA	125	-	"L" 400 + 170 x 210	280 x 160 x 175	11	BD35F	Mechanical
Air-cooled	U125X000R11111AA	125	-	"O" 240 x 210 x 85	280 x 160 x 175	9	BD35F	Mechanical
Water-cooled SP	U125X000R11311AA	125	-	"O" 240 x 210 x 85	280 x 160 x 175	11	BD35F	Mechanical
Air-cooled	U150X000P11111AA	150	-	"Flat" 386 x 361	280 x 160 x 175	9	BD35F	Mechanical
Air-cooled	U150X000R11111AA	150	-	"O" 320 x 100 x 230	280 x 160 x 175	9	BD35F	Mechanical
Air-cooled	U150X000R11111AB	150	-	"O" 320 x 100 x 230	280 x 160 x 175	9	BD35F	Mechanical
Air-cooled	U150X000F11111AA	150	-	275 x 220 x 70	280 x 160 x 175	10	BD35F	Mechanical
Air-cooled	U200N000F11111AA	200	-	360 x 257 x 258	280 x 160 x 175	N/A	BD35F	Mechanical
Water-cooled SP	U150X000R11311AA	150	-	"O" 320 x 100 x 230	280 x 160 x 175	11	BD35F	Mechanical
Air-cooled	U200X000R11111AA	200	-	"O" 380 x 140 x 270	330 x 160 x 175	9	BD50F	Mechanical
<b>Freezer</b>								
Water-cooled SP	U000X041L13311AA	-	41	"L" 400 + 170 x 210	280 x 160 x 175	12	BD35F	Mechanical
Air-cooled	U000X066P13111AA	-	66	"Flat" 1200 x 190	330 x 160 x 175	12	BD50F	Mechanical
Air-cooled	U000X086P13111AA	-	86	"Flat" 1000 x 270	330 x 160 x 175	12	BD50F	Mechanical
Air-cooled	U000X133P13111AA	-	133	"Flat" 1370 x 300	330 x 160 x 175	12	BD50F	Mechanical
Water-cooled Magnum	U000X141P13411AA	-	141	"Flat" 1370 x 300	420 x 240 x 400	15	BD80F	Mechanical
<b>Fridge/Freezer</b>								
Air-cooled	U060X020P17161AA	60	20	"Flat" 350 x 130	280 x 160 x 175	9	BD35F	ITC
Air-cooled	U060X020P17151AA	60	20	"Flat" 350 x 130	280 x 160 x 175	9	BD35F	SEC
Air-cooled	U080X026P17161AA	80	26	"Flat" 350 x 250	280 x 160 x 175	9	BD35F	ITC
Air-cooled	U080X026P17151AA	80	26	"Flat" 350 x 250	280 x 160 x 175	9	BD35F	SEC
Air-cooled	U100X033L17161AA	100	33	"L" 250 + 110x 350	280 x 160 x 175	14	BD35F	ITC
Air-cooled	U125X041L17161AA	125	41	"L" 400 + 170 x 210	280 x 160 x 175	9	BD35F	ITC
Air-cooled	U125X041L17151AA	125	41	"L" 400 + 170 x 210	280 x 160 x 175	9	BD35F	SEC
Air-cooled	U125X041R17161AA	125	41	"O" 240 x 210 x 85	280 x 160 x 175	9	BD35F	ITC
Air-cooled	U125X041R17151AA	125	41	"O" 240 x 210 x 85	280 x 160 x 175	9	BD35F	SEC
Air-cooled	U150X050P17161AA	150	50	"Flat" 386 x 361	280 x 160 x 175	9	BD35F	ITC
Air-cooled	U150X050R17161AA	150	50	"O" 320 x 100 x 230	330 x 160 x 175	9	BD50F	ITC
Air-cooled	U150X050R17151AA	150	50	"O" 320 x 100 x 230	330 x 160 x 175	9	BD50F	SEC
Water-cooled Magnum	U200X066R12411AA	200	66	"O" 380 x 140 x 270	330 x 160 x 175	15	BD50F	Dual
Air-cooled	U200X066P12111AA	200	66	"Flat" 1200 x 190	330 x 160 x 175	12	BD50F	Dual
Air-cooled	U260X086P12111AA	260	86	"Flat" 1000 x 270	330 x 160 x 175	11	BD50F	Dual
Water-cooled Magnum	U260X086P12411AA	260	86	"Flat" 1000 x 270	330 x 160 x 175	14	BD50F	Dual
Air-cooled	U400X133P12111AA	400	133	"Flat" 1370 x 300	330 x 160 x 175	12	BD50F	Dual
Water-cooled Magnum	U400X133P12411AA	400	133	"Flat" 1370 x 300	330 x 160 x 175	16	BD50F	Dual
Air-cooled	U170X056P12111AA	170	56	"Flat" 815 x 210	330 x 160 x 175	11	BD50F	Dual
Air-cooled	U170X056P17161AA	170	56	"Flat" 815 x 210	330 x 160 x 175	11	BD50F	ITC
Air-cooled	U100X035A17161AA	100	35	300 x 210 x 60	280 x 160 x 175	14	BD35F	ITC+
Air-cooled	U150X050A17161AA	150	50	355 x 280 x 60	330 x 160 x 175	16	BD50F	ITC+

# Isotherm Cooling Units

## Fridge/Freezer ITC+, Accessories

### Technical Data:

System	Unit code	Max Volume (l)		Holding Plate (l)	Dimensions compressor W x H x D (mm)	Weight (kg)	Secop Compressor type	Control
Fridge/Freezer		Fridge	Freezer					
Air-cooled	U200X065A17161AA	200	65	6	330 x 160 x 175	16	BD50F	ITC+
Water-cooled Magnum	U150X050A17461AA	150	50	3	420 x 240 x 200	19	BD50F	ITC+
Water-cooled SP	U100X035A17361AA	100	35	2	280 x 160 x 175	14	BD35F	ITC+
Water-cooled SP	U150X050A17361AA	150	50	3	420 x 240 x 200	18	BD50F	ITC+

### IPN Intelligent Part Numbering

With the Isotherm IPN system (Intelligent Part Numbering), it will be extremely easy to configure your cooling system for the best customization! The self-explanatory part number structure can clearly specify units' features at a glance, just by reading it.

The structure consists of 16 digits, the first 8 of which are dedicated to the explanation of:

- Function (fridge, freezer or fridge freezer)
- Maximum liters capacity (as fridge or freezer, based on minimum insulation requirements according to Isotherm specifications)

### IPN Isotherm system, your cooling unit has never been so easy to understand and configure!



U125X000 In this case the unit is a FRIDGE - with maximum 125 lt. capacity

U125X041 In this case the unit is a FRIDGE - FREEZER - with maximum 125 lt. capacity as fridge and 41 lt. as freezer

U000X041 In this case the unit is a FREEZER - with maximum 41 lt. capacity

### Cooling Units Accessories:

Picture	Order Number	Description
	SEH00017HA	Power Pack 100/240V 50/60Hz - EU plug
	SEH00018HA	Power Pack 100/240V 50/60Hz - USA plug
	SEH00019HA	Power Pack 100/240V 50/60Hz - AU plug
	SEH00020HA	Power Pack 100/240V 50/60Hz - UK plug
	SED00035GA	Power Pack for BD80 230V 50/60Hz - EU plug
	SED00035PA	Power Pack for BD80 115V 50/60Hz - USA plug
	SEC00004DA	Internal light kit 12 – 24 V
	SBE00004AA	Air hose adapter kit Ø 106 mm (l = 1.500 mm)
	SGE00012AA	"Click-on" bracket for an easy compressor' installation
	SEA00048DB	High speed Thermostat kit for freezers
	SBD00031XA	Extension tube with couplings (l = 1 m)
	SBD00154XA	Extension tube with couplings (l = 2 m)
	SBD00155XA	Extension tube with couplings (l = 3 m)
	SBE00006AA	Zinc anode for sea water-cooled SP units

Picture	Order Number	Description
	SBE00008AA	Zinc anode, 3/8", for sea water-cooled Magnum units
	SGC00005AA	Evaporator door O-SMALL
	SGC00004AA	Evaporator door O-MEDIUM
	SGC00003AA	Evaporator door O-BIG
	SEA00004DB	Double thermostat kit, 10 °C to -20 °C
	SFD00008AA	Skin fitting valve kit for SP units
	SBE00071CA	Air circulation fan
	SGC00152AA	Foldable bottle rack
	SGC00006AA	Ice cube kit for holding plate

# Air-cooled

## Cooling Unit BD35F

Select your control device



Mechanical



ITC



SEC



SPECIFICATIONS	
Evaporator	Flat
Max. Box Volume Fridge (l)	60
Max. Box Volume Freezer (l)	20

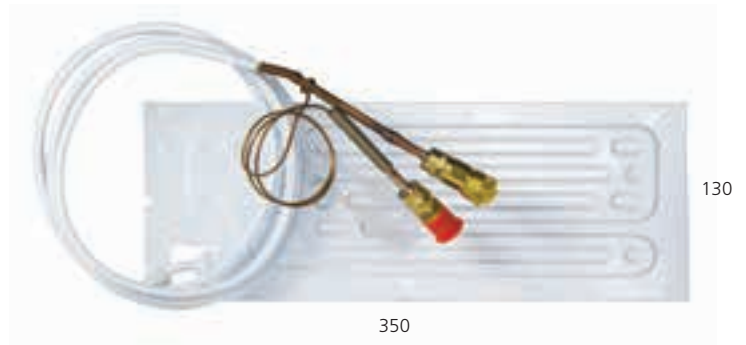

FUNCTION	UNIT CODE	DESCRIPTION	CONTROL
Fridge	U060X000P11111AA	FRIDGE UNIT 60LV „FLAT“ EVAPORATOR 350X130MM (2005)	Mechanical
Fridge/freezer	U060X020P17161AA	FRIDGE OR FREEZER UNIT 60-20LV „FLAT“ EVAPORATOR 350X130MM - ITC (2005)	ITC
Fridge/freezer	U060X020P17151AA	FRIDGE OR FREEZER UNIT 60-20LV „FLAT“ EVAPORATOR 350X130MM - SEC (2005)	SEC

SPECIFICATIONS	
Evaporator	Flat
Max. Box Volume Fridge (l)	80
Max. Box Volume Freezer (l)	26



CATEGORY	UNIT CODE	DESCRIPTION	CONTROL
Fridge	U080X000P11111AA	FRIDGE UNIT 80LV „FLAT“ EVAPORATOR 350X250MM (GE80)	Mechanical
Fridge/freezer	U080X026P17161AA	FRIDGE OR FREEZER UNIT 80-26LV „FLAT“ EVAPORATOR 350X250MM - ITC (GE80)	ITC
Fridge/freezer	U080X026P17151AA	FRIDGE OR FREEZER UNIT 80-26LV „FLAT“ EVAPORATOR 350X250MM - SEC (GE80)	SEC

# Air-cooled

## Cooling Unit BD35F

Select your control device



Mechanical



ITC



SEC



### SPECIFICATIONS

Evaporator	L
Max. Box Volume Fridge (l)	100
Max. Box Volume Freezer (l)	33



CATEGORY	UNIT CODE	DESCRIPTION	CONTROL
Fridge	U100X000L11111AA	FRIDGE UNIT 100LV EVAPORATOR „L“ 250+110x350mm (2007)	Mechanical
Fridge/freezer	U100X033L17161AA	FRIDGE OR FREEZER UNIT 100-33LV „L“ EVAPORATOR 250+110x350mm - ITC (2007)	ITC

### SPECIFICATIONS

Evaporator	L
Max. Box Volume Fridge (l)	100

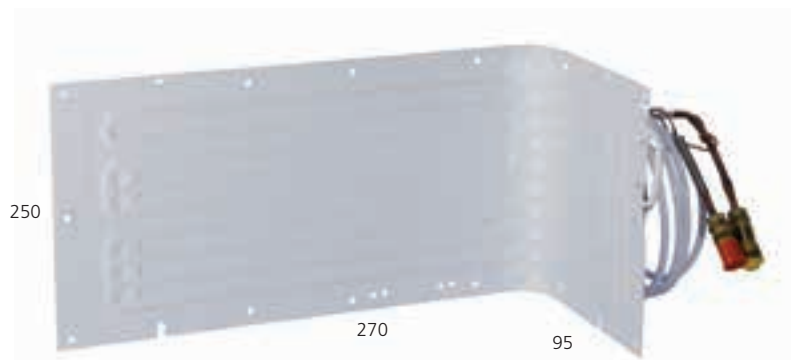

CATEGORY	UNIT CODE	DESCRIPTION	CONTROL
Fridge	U100X000L11111AC	FRIDGE UNIT 100LV EVAPORATOR „L“ 270+95X250MM (2018)	Mechanical

# Air-cooled

## Cooling Unit BD35F

Select your control device



Mechanical



ITC



SEC



SPECIFICATIONS	
Evaporator	L
Max. Box Volume Fridge (l)	125
Max. Box Volume Freezer (l)	41

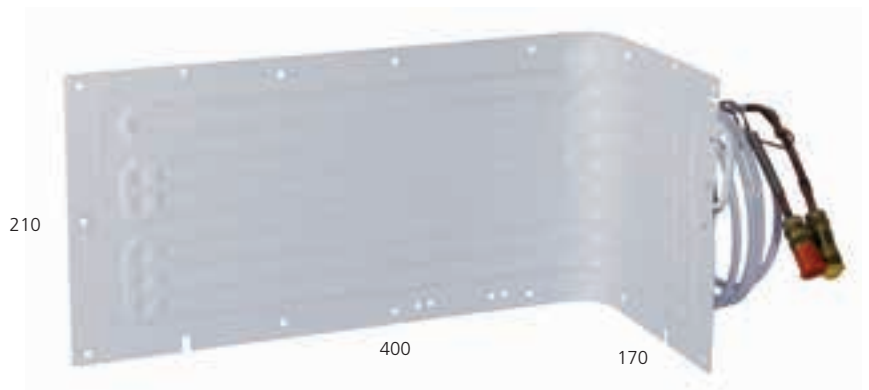

CATEGORY	UNIT CODE	DESCRIPTION	CONTROL
Fridge	U125X000L11111AA	FRIDGE UNIT 125LVV "L" BIG EVAPORATOR 400+170X210MM (2010)	Mechanical
Fridge/freezer	U125X041L17161AA	FRIDGE OR FREEZER UNIT 125-41LVV "L" BIG EVAPORATOR 400+170X210MM - ITC (2010)	ITC
Fridge/freezer	U125X041L17151AA	FRIDGE OR FREEZER UNIT 125-41LVV "L" BIG EVAPORATOR 400+170X210MM - SEC (2010)	SEC

SPECIFICATIONS	
Evaporator	O
Max. Box Volume Fridge (l)	125
Max. Box Volume Freezer (l)	41



CATEGORY	UNIT CODE	DESCRIPTION	CONTROL
Fridge	U125X000R11111AA	FRIDGE UNIT 125LVV „O“ EVAPORATOR 4L 240X210X85MM (2001)	Mechanical
Fridge/freezer	U125X041R17161AA	FRIDGE OR FREEZER UNIT 125-41LVV „O“ EVAPORATOR 4L 240X210X85MM - ITC (2001)	ITC
Fridge/freezer	U125X041R17151AA	FRIDGE OR FREEZER UNIT 125-41LVV „O“ EVAPORATOR 4L 240X210X85MM - SEC (2001)	SEC



# Air-cooled

## Cooling Unit BD35F

Select your control device



Mechanical



ITC



SEC



160

280

175

### SPECIFICATIONS

Evaporator	Flat
Max. Box Volume Fridge (l)	150
Max. Box Volume Freezer (l)	50



361

386

FUNCTION	UNIT CODE	DESCRIPTION	CONTROL
Fridge	U150X000P11111AA	FRIDGE UNIT 150LV EVAPORATOR „FLAT“ 386x361mm (GE150)	Mechanical
Fridge/freezer	U150X050P17161AA	FRIDGE OR FREEZER UNIT 150-50LV „FLAT“ EVAPORATOR 386X361MM - ITC (GE150)	ITC

### SPECIFICATIONS

Evaporator	O
Max. Box Volume Fridge (l)	150
Max. Box Volume Freezer (l)	50

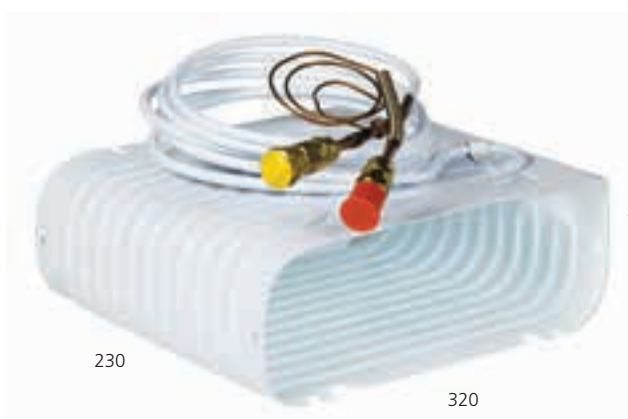

230

320

100

CATEGORY	UNIT CODE	DESCRIPTION	CONTROL
Fridge	U150X000R11111AA	FRIDGE UNIT 150LV „O“ EVAPORATOR 7,5L 320X100X230MM (2301)	Mechanical
Fridge	U150X000R11111AB	FRIDGE UNIT 150LV „O“ EVAPORATOR 7,5L 320X100X230MM - EVAPORATOR DOOR (2309)	Mechanical
Fridge/freezer	U150X050R17161AA	FRIDGE OR FREEZER UNIT 150-50LV „O“ EVAPORATOR 7,5L 320X100X230MM - ITC (2301)	ITC
Fridge/freezer	U150X050R17151AA	FRIDGE OR FREEZER UNIT 150-50LV „O“ EVAPORATOR 7,5 320X100X230MM - SEC (2301)	SEC

# Air-cooled

## SPECIFICATIONS

Evaporator	275 x 220 x 70
Max. Box Volume Fridge (l)	150



CATEGORY	UNIT CODE	DESCRIPTION	CONTROL
Fridge	U150X000F11111AA	FRIDGE UNIT 150L/V FINS EVAPORATOR 275X220X70MM (VE150)	Mechanical

## SPECIFICATIONS

Evaporator	360 x 257 x 258
Max. Box Volume Fridge (l)	200



CATEGORY	UNIT CODE	DESCRIPTION	CONTROL
Fridge	U200N000F11111AA	VE200 PLUG&PLAY	Mechanical

# Air-cooled

## Cooling Unit BD50F

Select your control device



Mechanical



ITC



SEC



160

175

330

### SPECIFICATIONS

Evaporator	O
Max. Box Volume Fridge (l)	200



140

270

380

CATEGORY	UNIT CODE	DESCRIPTION	CONTROL
Fridge	U200X000R11111AA	FRIDGE UNIT 200LV „O“ EVAPORATOR 14L 380X140X270MM (2501)	Mechanical

### SPECIFICATIONS

Evaporator	Flat
Max. Box Volume Fridge (l)	200
Max. Box Volume Freezer (l)	66

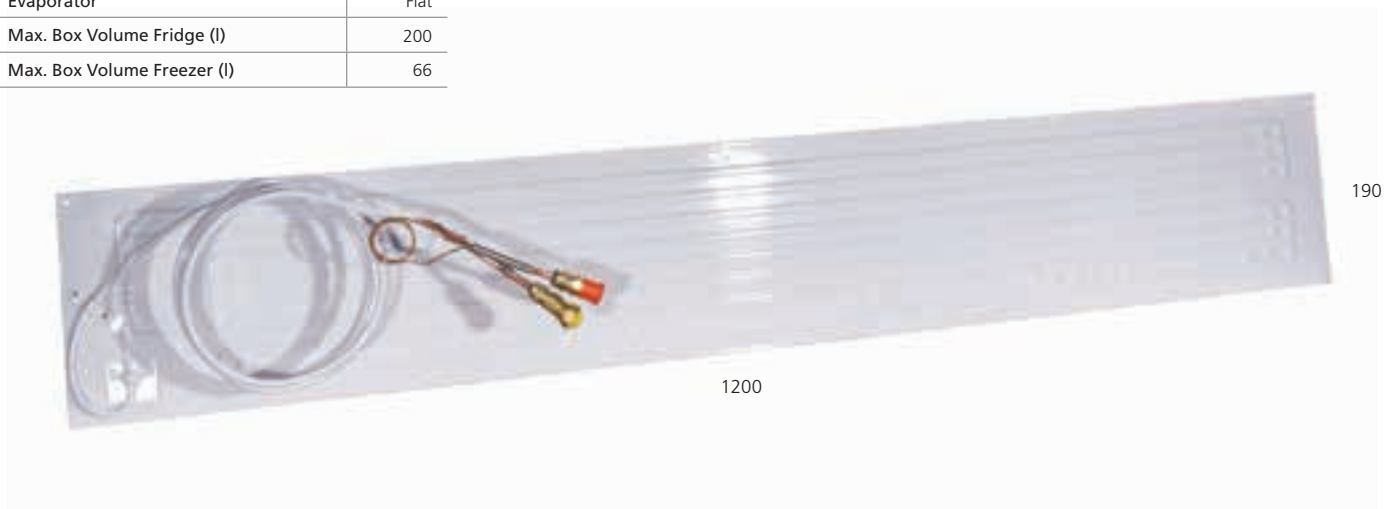

190

1200

CATEGORY	UNIT CODE	DESCRIPTION	CONTROL
Freezer	U000X066P13111AA	FREEZER UNIT 66LV „FLAT“ EVAPORATOR 1200x190mm (2016)	Mechanical
Fridge/freezer	U200X066P12111AA	FRIDGE OR FREEZER UNIT 200-66LV „FLAT“ EVAPORATOR 1200X190MM DUAL (2016)	Dual

# Air-cooled

## Cooling Unit BD50F

Select your control device



Mechanical



ITC



SEC



160

330

175

### SPECIFICATIONS

Evaporator	Flat
Max. Box Volume Fridge (l)	260
Max. Box Volume Freezer (l)	86



1000

270

CATEGORY	UNIT CODE	DESCRIPTION	CONTROL
Freezer	U000X086P13111AA	FREEZER UNIT 86L/V „FLAT“ EVAPORATOR 1000x270mm (2017)	Mechanical
Fridge/freezer	U260X086P12111AA	FRIDGE OR FREEZER UNIT 260-86L/V „FLAT“ EVAPORATOR 1000X270MM DUAL (2017)	Dual

### SPECIFICATIONS

Evaporator	Flat
Max. Box Volume Fridge (l)	400
Max. Box Volume Freezer (l)	133

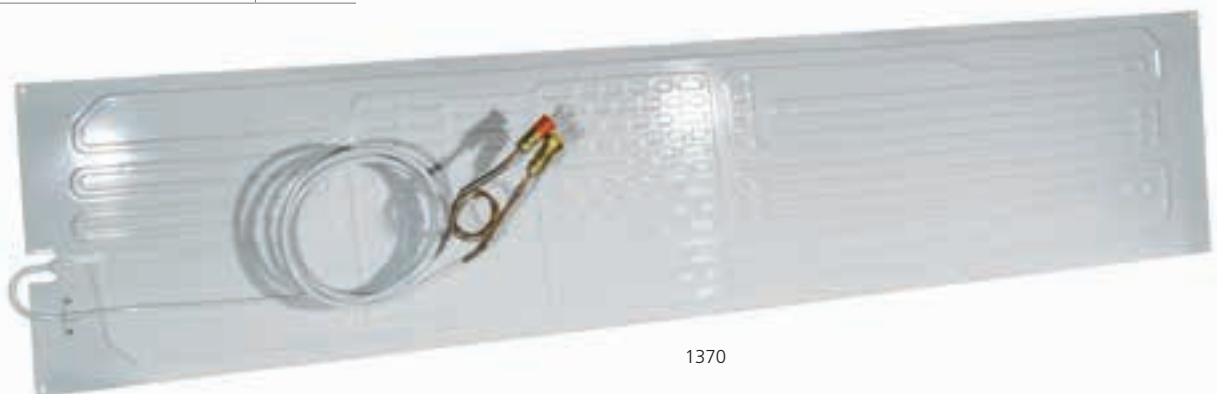

1370

300

CATEGORY	UNIT CODE	DESCRIPTION	CONTROL
Freezer	U000X133P13111AA	FREEZER UNIT 133L/V „FLAT“ EVAPORATOR 1370x300mm (2013)	Mechanical
Fridge/freezer	U400X133P12111AA	FRIDGE OR FREEZER UNIT 400-133L/V „FLAT“ EVAPORATOR 1370X300MM DUAL (2013)	Dual

# Air-cooled

## Cooling Unit BD50F

Select your control device



Mechanical



ITC



SEC



160

175

330

### SPECIFICATIONS

Evaporator	Flat
Max. Box Volume Fridge (l)	170
Max. Box Volume Freezer (l)	56



210

815

CATEGORY	UNIT CODE	DESCRIPTION	CONTROL
Fridge/freezer	U170X056P1211AA	FRIDGE OR FREEZER UNIT 170-56LV „FLAT“ EVAPORATOR 815x210mm DUAL (2012)	Dual
Fridge/freezer	U170X056P17161AA	FRIDGE OR FREEZER UNIT 170-56LV „FLAT“ EVAPORATOR 815x210mm - ITC (2012)	ITC

# Water-cooled SP

## Cooling Unit BD35F

Select your control device



Mechanical



ITC



SEC



175

160

280



SPECIFICATIONS	
Evaporator	L
Max. Box Volume Fridge (l)	100

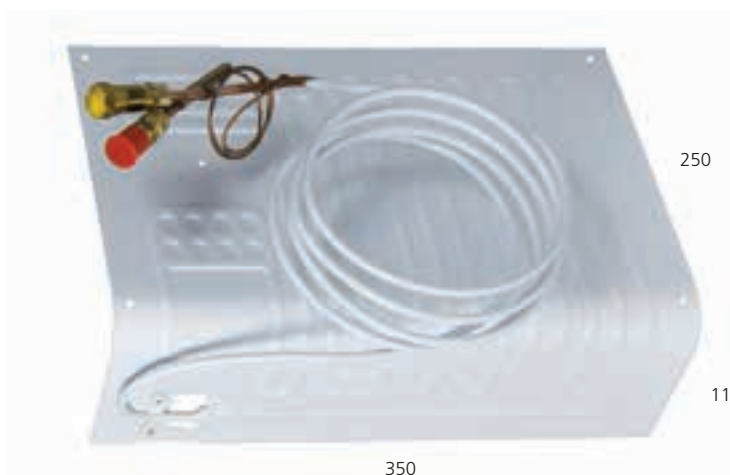

250

110

350

CATEGORY	UNIT CODE	DESCRIPTION	CONTROL
Fridge	U100X000L11311AA	FRIDGE UNIT 100L/SP EVAPORATOR „L“ 250+110X350MM (2057)	Mechanical

SPECIFICATIONS	
Evaporator	L
Max. Box Volume Fridge (l)	125
Max. Box Volume Freezer (l)	41

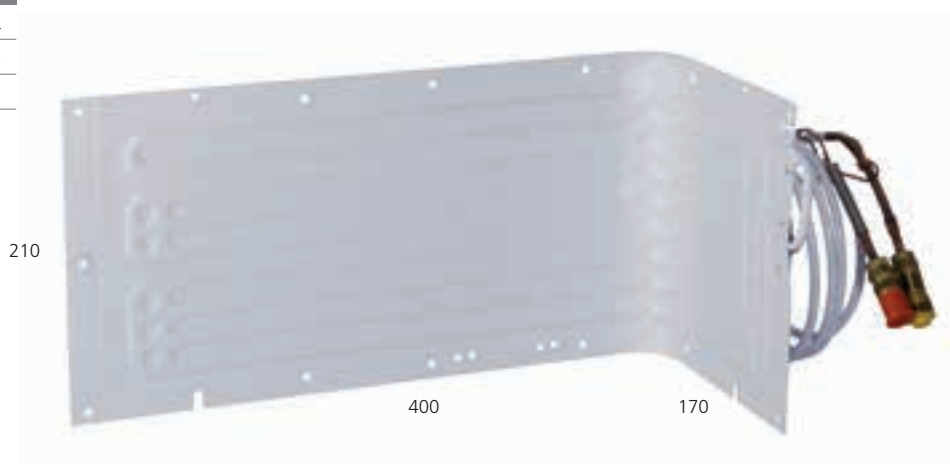

210

400

170

CATEGORY	UNIT CODE	DESCRIPTION	CONTROL
Fridge	U125X000L11311AA	FRIDGE UNIT 125L/SP „L“ EVAPORATOR 400+170X210MM (2050)	Mechanical
Freezer	U000X041L13311AA	FREEZER UNIT 41L/SP „L“ EVAPORATOR 400+170x210mm (2050)	Mechanical

# Water-cooled SP

## Cooling Unit BD35F

Select your control device



Mechanical



ITC



SEC



175

160

280



SPECIFICATIONS	
Evaporator	O
Max. Box Volume Fridge (l)	125

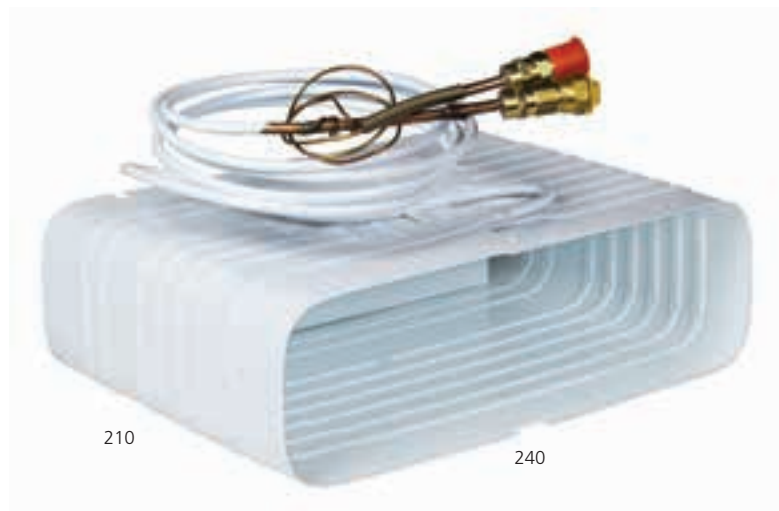

210

240

85

CATEGORY	UNIT CODE	DESCRIPTION	CONTROL
Fridge	U125X000R11311AA	FRIDGE UNIT 125L/SP „O“ EVAPORATOR 4L 240X210X85MM (2051)	Mechanical

SPECIFICATIONS	
Evaporator	O
Max. Box Volume Fridge (l)	150

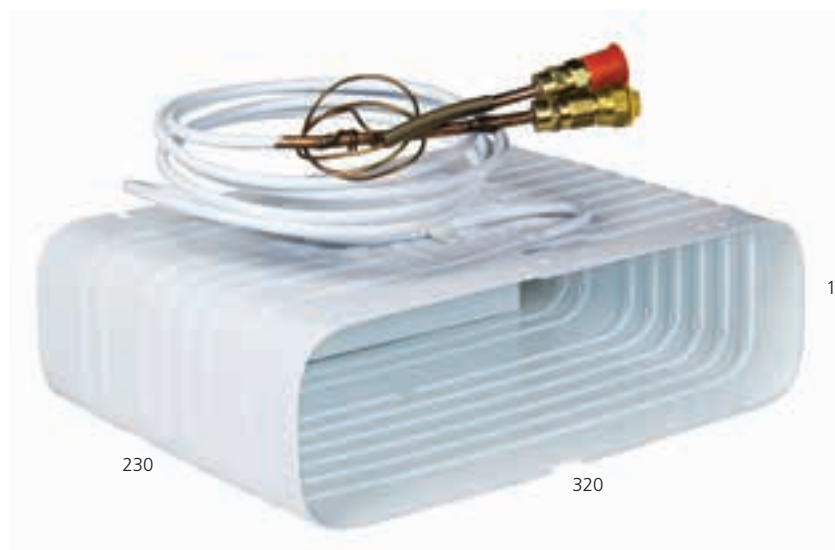

230

320

100

CATEGORY	UNIT CODE	DESCRIPTION	CONTROL
Fridge	U150X000R11311AA	FRIDGE UNIT 150L/SP „O“ EVAPORATOR 7,5L 320x100x230mm (2351)	Mechanical

# Water-cooled Magnum

## Cooling Unit BD50F

Select your control device

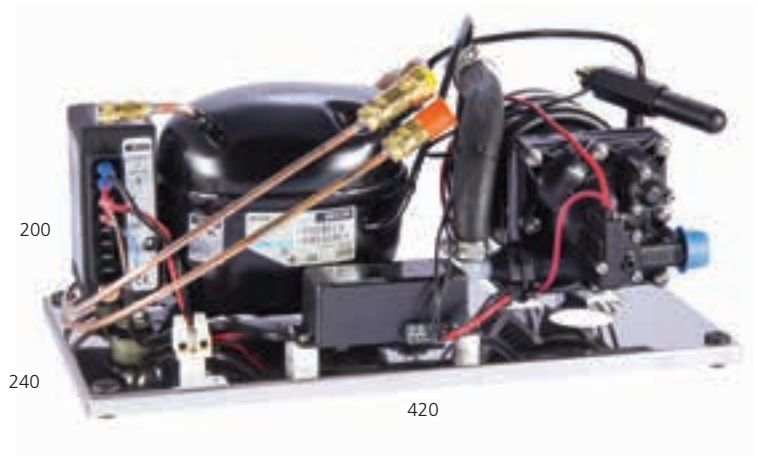

### SPECIFICATIONS

Evaporator	O
Max. Box Volume Fridge (l)	200
Max. Box Volume Freezer (l)	66



CATEGORY	UNIT CODE	DESCRIPTION	CONTROL
Fridge/freezer	U200X066R12411AA	FRIDGE OR FREEZER UNIT 200-66L/MAGNUM „O“ EVAPORATOR 14L 380X140X270MM (2505)	Dual

### SPECIFICATIONS

Evaporator	Flat
Max. Box Volume Fridge (l)	260
Max. Box Volume Freezer (l)	86

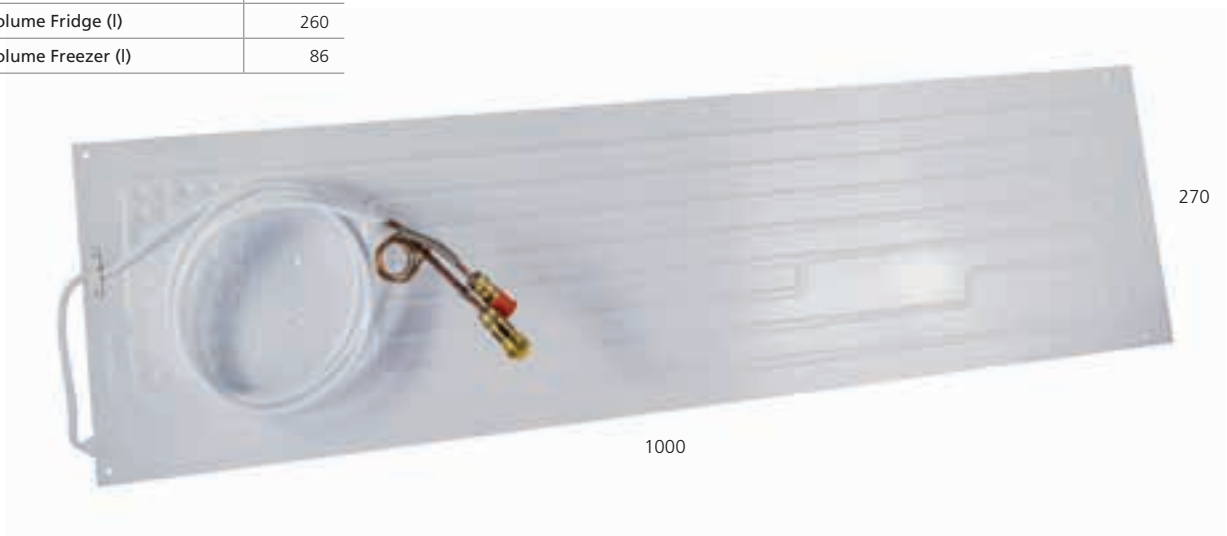

CATEGORY	UNIT CODE	DESCRIPTION	CONTROL
Fridge/freezer	U260X086P12411AA	FRIDGE OR FREEZER UNIT 260-86L/MAGNUM „FLAT“ EVAPORATOR 1000X270MM DUAL (2513)	Dual



# Water-cooled Magnum

## Cooling Unit BD50F

Select your control device

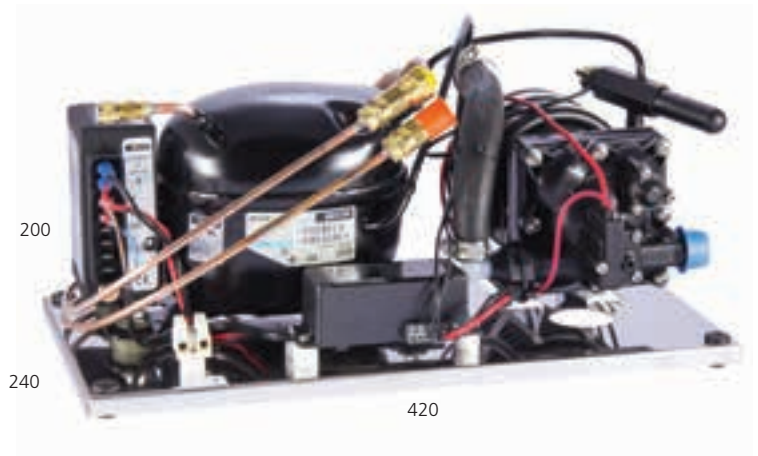

### SPECIFICATIONS

Evaporator	Flat
Max. Box Volume Fridge (l)	400
Max. Box Volume Freezer (l)	133

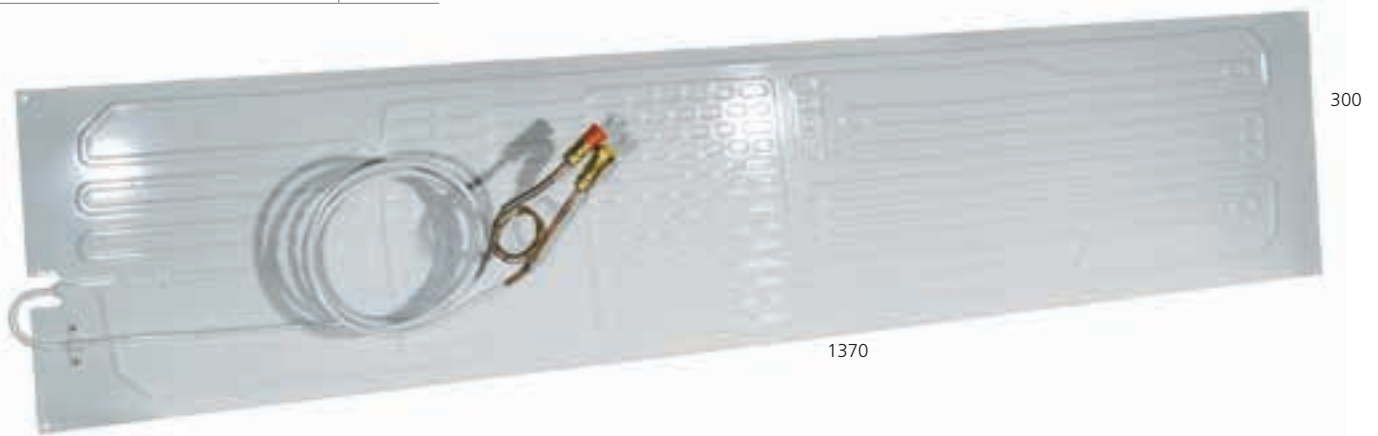

CATEGORY	UNIT CODE	DESCRIPTION	CONTROL
Fridge/freezer	U400X133P12411AA	FRIDGE OR FREEZER UNIT 400-133L/MAGNUM „FLAT“ EVAPORATOR 1370X300MM DUAL (2507)	Dual

# Water-cooled Magnum

## Cooling Unit BD80F

Select your control device



Mechanical



ITC



SEC

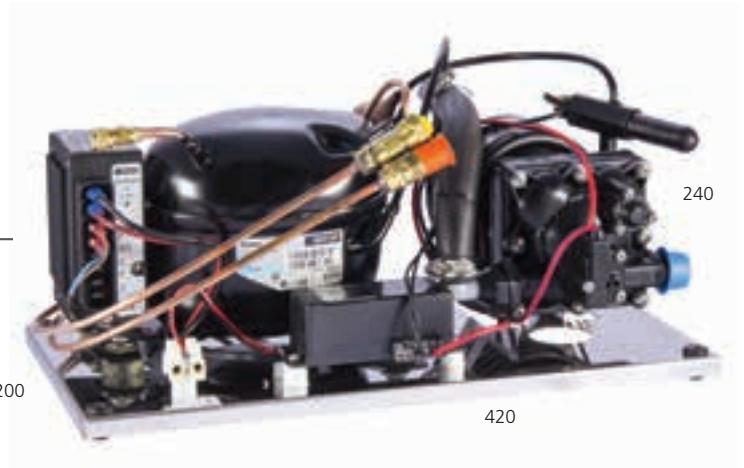

200

420

240

### SPECIFICATIONS

Evaporator	Flat
Max. Box Volume Freezer (l)	141

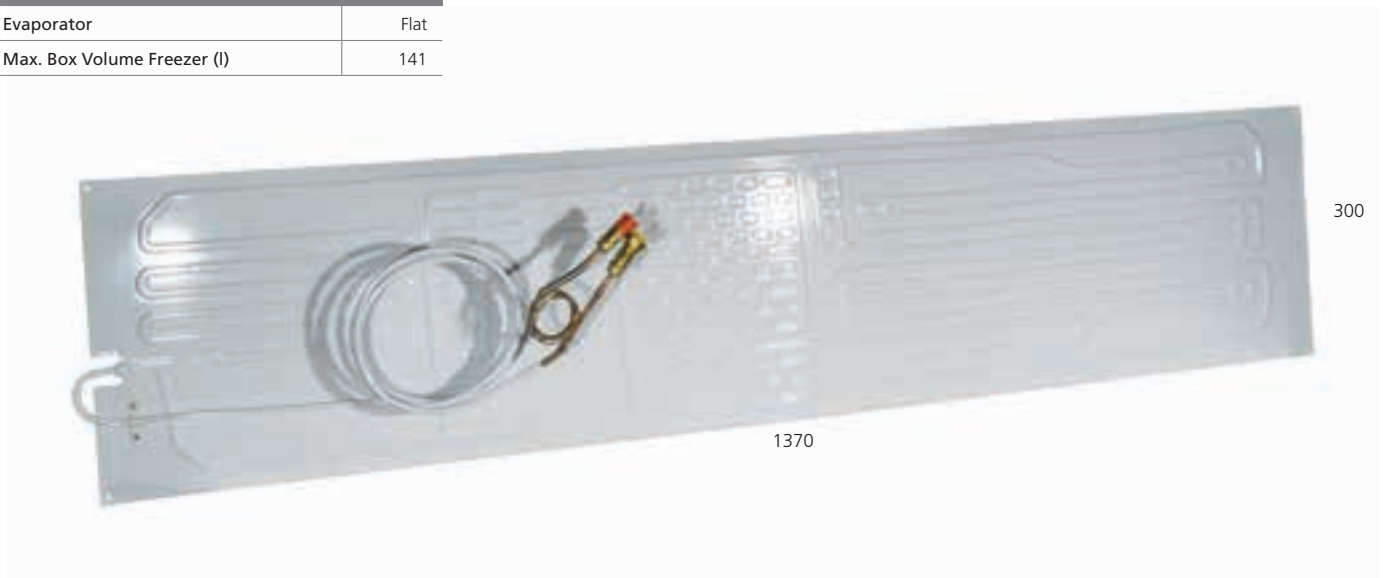

1370

300

CATEGORY	UNIT CODE	DESCRIPTION	CONTROL
Freezer	U000X141P13411AA	FREEZER UNIT 141L/MAGNUM „FLAT“ EVAPORATOR 1370x300mm (2607)	Mechanical

# Cooling Unit ITC+

## Air-Cooled

SPECIFICATIONS	
Plate	2L
Max. Box Volume Fridge (l)	100
Max. Box Volume Freezer (l)	35



CATEGORY	UNIT CODE	COMPRESSOR	DESCRIPTION	CONTROL
Fridge/freezer	U100X035A17161AA	BD35F	FRIDGE OR FREEZER UNIT 100-35LV HOLDING PLATE 2L - ITC+ (3201)	ITC+

SPECIFICATIONS	
Plate	3L
Max. Box Volume Fridge (l)	150
Max. Box Volume Freezer (l)	50



CATEGORY	UNIT CODE	COMPRESSOR	DESCRIPTION	CONTROL
Fridge/freezer	U150X050A17161AA	BD50F	FRIDGE OR FREEZER UNIT 150-50LV HOLDING PLATE 3L - ITC+ (3701)	ITC+

SPECIFICATIONS	
Plate	6L
Max. Box Volume Fridge (l)	200
Max. Box Volume Freezer (l)	65



CATEGORY	UNIT CODE	COMPRESSOR	DESCRIPTION	CONTROL
Fridge/freezer	U200X065A17161AA	BD50F	FRIDGE OR FREEZER UNIT 200-65LV HOLDING PLATE 6L - ITC+	ITC+

# Cooling Unit ITC+

## Water Cooled SP

### SPECIFICATIONS

Plate	2L
Max. Box Volume Fridge (l)	100
Max. Box Volume Freezer (l)	35



CATEGORY	UNIT CODE	COMPRESSOR	DESCRIPTION	CONTROL
Fridge/freezer	U100X035A17361AA	BD35F	FRIDGE OR FREEZER UNIT 100-35L/SP HOLDING PLATE 2L - ITC+ (3251)	ITC+

### SPECIFICATIONS

Plate	3L
Max. Box Volume Fridge (l)	150
Max. Box Volume Freezer (l)	50



CATEGORY	UNIT CODE	COMPRESSOR	DESCRIPTION	CONTROL
Fridge/freezer	U150X050A17361AA	BD50F	FRIDGE OR FREEZER UNIT 150-50L/SP HOLDING PLATE 3L - ITC+ (3751)	ITC+

### SPECIFICATIONS

Plate	6L
Max. Box Volume Fridge (l)	200
Max. Box Volume Freezer (l)	65



CATEGORY	UNIT CODE	COMPRESSOR	DESCRIPTION	CONTROL
Fridge/freezer	U200X065A17361AA	BD50F	FRIDGE OR FREEZER UNIT 200-65L/SP HOLDING PLATE 6L - ITC+	ITC+

# Cooling Unit ITC+

## Water Cooled Magnum

### SPECIFICATIONS

Plate	3L
Max. Box Volume Fridge (l)	150
Max. Box Volume Freezer (l)	50



CATEGORY	UNIT CODE	COMPRESSOR	DESCRIPTION	CONTROL
Fridge/freezer	U150X050A17461AA	BD50F	FRIDGE OR FREEZER UNIT 150-50L/MAGNUM HOLDING PLATE 3L - ITC+ (4201)	ITC+

### SPECIFICATIONS

Plate	6L
Max. Box Volume Fridge (l)	200
Max. Box Volume Freezer (l)	65



CATEGORY	UNIT CODE	COMPRESSOR	DESCRIPTION	CONTROL
Fridge/freezer	U200X065A17461AA	BD50F	FRIDGE OR FREEZER UNIT 200-65L/MAGNUM HOLDING PLATE 6L - ITC+ (4701)	ITC+

# Special Design

## Refrigerators and Freezers

---

For perfect integration into the interior design of the boat, Indel Webasto Marine products must offer a high level of customization options. Seamless integration of isotherm products into a boat's interior design is at the heart of Indel Webasto Marine's offering of high-level customization options. Projects are carried out in close collaboration with shipyards. This approach is the focus of the projects and allows for extraordinary design and unusual installation.

Indel Webasto Marine conducts a thorough study to determine the best solution which fits both economic and technical constraints.



**Customized solutions to fit any size, shape and demand!**



Indel Webasto Marine offers tailored refrigeration and freezer solutions to meet customer needs even on very complex projects. Do not hesitate to contact us for more detailed information.

### Product Specifications:

- Completely tailored solutions
- Overall compatibility with the boat's interior design
- The custom-built approach in the product study assures an easy installation of the unit as well as an excellent effect on board
- Production technology is chosen according to the customer's request (small quantity, glass fiber boxes, high quantity, rotomoulding technology)





## Produce fresh ice on board

Serving drinks on board is great. But being able to serve them with ice cubes is even better. Indel Webasto Marine offers boat owners the perfect solutions to produce fresh ice on board.



# Ice Makers

<b>IceDrink</b>	<b>98</b>
IceDrink Clear	98
IceDrink Clear WT	98
<hr/>	
<b>IceMaker</b>	<b>99</b>
IceMaker White	99
IceMaker White WT Inox Clean Touch	99
IceMaker White Low Profile	99
<hr/>	
IceMaker White BI29	100

# Ice Makers

## IceDrink Clear, IceDrink Clear WT

Indel Webasto Marine provides with the perfect solution to serve cool drinks on board. Our wide offer of different technologies allows users to choose between clear ice and white ice.

The White ice makers, are ideal for installations in hot climate conditions thanks to the combination of the refrigerated cabinet which maintains ice cubes frozen and the exclusive designed condensing ventilation.

The Clear Ice Maker, thanks to the exclusive Spray technology, can produce a large amount of ice cubes up to 18 kg per day. It has the best production capacity ratio of the market, providing high quality ice cubes, compact & crystalline, ideal for your cocktails and drinks. An integrated water tank (WT) is available as option for the direct supply of mineral water.



### Advantages of the Isotherm IceDrink Clear:

- Complete stainless steel design
- Production capacity of 18 kg per day
- Spray technology for clear ice
- Available both in 115 V 60 Hz and 230 V 50 or 60 Hz
- Quality cubes: compact, cold and crystalline dropped into the collection bin (not refrigerated) meeting the ice demand even at peak times
- Front to rear ventilation
- Three sides flange option for critical space installations

### Advantages of the Isotherm IceDrink Clear WT:

- Integrated water tank for the supply of mineral water
- Same external dimensions of the standard Clear Ice version
- Easy to refill just by opening the front lid and pouring water in the dedicated bin



# Ice Makers

IceMaker White, IceMaker White WT Inox Clean Touch

IceMaker White Low Profile



## Advantages of the Isotherm

### IceMaker White:

- Available with white door or stainless steel finishing
- Production capacity of 8 kg per day
- Reliable white ice technology
- Various customization possibilities for different installations just like with the CRUISE classic fridges and freezers
- Front ventilation only
- Refrigerated collection bin to keep the ice cubes frozen

### Advantages of the Isotherm IceMaker White WT Inox Clean Touch:

- Stainless Steel door in Inox Clean Touch, anti-finger print treated
- Up to 4,6 kg day of ice cubes production
- Removable water tank easy to clean and refill
- AC/DC solution capable to produce and maintain ice in both power supplies
- Automatic low power setting mode in DC
- External led indicator of empty water tank



## Advantages of the Isotherm IceMaker

### White Low Profile:

- Rear position compressor for a low height profile Ice Maker
- Reliable performing technology, ice production 8 kg per day
- Refrigerated cabinet to store and maintain frozen ice cubes
- High quality stainless steel for outer cockpit applications
- Refined flush installation thanks to a flush 3 sides mounting flange with the 4<sup>th</sup> one as option
- Exclusive designed condensing forced ventilation to grant maximum performances in hot conditions
- Extra compact dimensions in height
- Ideal for installation in critical areas where the height is limited

# Ice Makers

## IceMaker White BI29

### Advantages of the Isotherm

#### IceMaker White BI29:

- Sturdy built in design casing
- Refrigerated cabinet to store and maintain frozen ice cubes
- The thermoformed interior, made with a solid one-piece structure, allows easy cleaning and defrosting and ensures perfect insulation
- Ice production capacity of 2,5 Kg per day
- Extra low profile to easily fit in cockpit applications or below seats
- Equipped with extra-long roller slides to use the box as a drawer



### Product Overview: Isotherm IceDrink and Ice Makers

Type	Gross volume (l)	Dimensions W x H x D (mm)	Weight (kg)	Power consumption (Watt)	Power Supply (Volt/Hz)
IceDrink Clear	14	355 x 590 x 407	28	320	230 V AC - 50 Hz or 115 V AC - 60 Hz
IceDrink Clear WT	14	356 x 590 x 407	28	320	230 V AC - 50 Hz or 115 V AC - 60 Hz
IceMaker White, White Door	20	356 x 630 x 400*	29	180	230 V AC - 50 Hz or 115 V AC - 60 Hz
IceMaker White Inox	20	371 x 626 x 430**	29	180	230 V AC - 50 Hz or 115 V AC - 60 Hz
IceMaker White Low Profile	20	371 x 475 x 625**	28	180	230 V AC - 50 Hz or 115 V AC - 60 Hz
IceMaker White WT Inox Clean Touch	20	371 x 626 x 501**	29	280	DC/AC 12V or 24V 230 V - 50 Hz or 115 V - 60 Hz
BI29 IceMaker	29	342 x 330* x 726	24	180	230 V AC - 50 Hz or 115 V AC - 60 Hz

\* Add 40mm for door dimension    \*\* Width IceMaker White Inox flange 20mm per side

TYPE	ORDER NUMBER	DESCRIPTION
IceDrink Clear	5S21A11A0N000	ICE DRINK CLEAR 230V/50HZ
	5S21A14A0N000	ICE DRINK CLEAR 115V/60HZ
IceDrink Clear WT	5S18A11A0T000	ICE DRINK CLEAR WT 230V/50HZ
	5S18A14A0T000	ICE DRINK CLEAR WT 115V/60HZ
IceMaker White	5W08A21CGN000	ICE MAKER WHITE WHITE DOOR 230V/50Hz
	5W08A24CEN001	ICE MAKER WHITE WHITE DOOR 115V/60Hz
IceMaker White Inox	5W08A11IMN000	ICE MAKER WHITE INOX 230V/50Hz
	5W08A14IMN000	ICE MAKER WHITE INOX 115V/60Hz
IceMaker White Low Profile	5W08L11IMN000	ICE MAKER WHITE LOW PROFILE INOX 230V/50Hz
	5W08L14IMN000	ICE MAKER WHITE LOW PROFILE INOX 115V/60Hz
IceMaker White WT Inox Clean Touch	5W05A35CMRE00	ICE MAKER WHITE INOX CLEAN TOUCH WT 12V DC-230V/50HZ AC
	5W05A36CMRU00	ICE MAKER WHITE INOX CLEAN TOUCH WT 12V DC-115V/60HZ AC
	5W05A37CMRE00	ICE MAKER WHITE INOX CLEAN TOUCH WT 24V DC-230V/50HZ AC
	5W05A38CMRU00	ICE MAKER WHITE INOX CLEAN TOUCH WT 24V DC-115V/60HZ AC
BI29 IceMaker	5W03A21CAN000	ICE MAKER WHITE BI29(II) 230V/50Hz
	5W03A24CAN000	ICE MAKER WHITE BI29(II) 115V/60Hz





## Serve wine or champagne at the perfect temperature

Indel Webasto Marine offers its customers the opportunity to have wine cooler and cellars on board. This high class equipment enables boat owners to serve and store great wine or champagne at the perfect temperature.

## Wine Cellars & Cooler

### Wine Cooler

Divino The One	104
Divino The Eight	104

---

### Wine Cellar

Divino 23	105
Divino 35	105

---

# Divino Wine Cellars & Cooler

## Divino The One - Divino The Eight

Serve great wine or champagne.

### Divino The One

Divino The One is an integrated wine cooler that keeps wine perfectly chilled during service. It's extremely simple to use: just touch any part of the crown with your finger to activate your Divino The One. Touch and serve your wine always at the right temperature.

The Divino The One is based on a powerful thermoelectric core unit that creates an instant cold air jacket around the bottle.

Once integrated, the only visible part will be the stainless steel crown, capable to match the typical marine-style applications.

### Using it will make your wine tasting more fun!

Tap the crown three times and scroll through the colour selection of 27 options to personalize it.

By tapping four times the crown, the illumination will gently fade through the full colour selection.

- Perfect serving temperature for your wine
- Double operating function for white and red wine
- Elegant integrated design
- Jacket of cold air: no more wet bottles and water stains
- Performing and reliable: 3 years warranty, maintenance free

### Divino The Eight

The new Divino The Eight is a premium wine storage device, capable to welcome up to 8 bottles of wine. It is a wine cellar DC 12/24V based, with the optional of Isotherm AC/DC Power Pack for multiple purposes.

Its glass-based transparent door and the 3 sided flush mounting flange in stainless steel allow the best on board integration: A specific locking mechanism prevents unwanted opening of the door in rough seas.



### Advantages of the Divino The Eight:

- Elegant and practical design, double glass chamber sealed door DC based
- Exclusive stainless steel bottle rack, to store 4 bottles in two rows (8 bottles in total)
- Interior LED light
- Custom temperature settings for white or red wine



### Divino The One - a brief tour



#### 1. Smart-touch crown

- Two different finishes: polished and brushed stainless steel
- Control with just a touch
- Crafted from stainless steel
- Seamless edge-to-edge curve
- Polished to a mirror finish (not plated)
- No buttons or displays needed

#### 2. Interactive LED lighting

- 27 colours
- Select colour using touch
- Option to use without light
- Colour fade mode

#### 3. Simple installation

- Bottom fixing clamp included in the supply
- Ideal for inner and outer cockpit application
- Does not require specialist installation
- Install into a 154 mm hole
- Super compact: 160 mm wide, 300 mm deep
- Low power, uses only 60 W
- 12V DC as standard, Isotherm AC/DC power supply ready for AC application

#### 4. Patented Kryolux™ Technology

- Completely dry cooling
- No ice, water, CFCs or other refillables
- Caters for extra wide 75 cl bottles
- Automatic standby after 2 hours
- Runs silently



# Divino Wine Cellars & Cooler

## Divino 23, Divino 35



### Divino 23 & Divino 35: safe on board storage for wine and champagne.

Both 23 and 35 bottle wine cellars can be built into the dressers or columns of modular furniture with no modification of its design.

For a perfect integration, the profile of the door is totally lined up with the doors of the furniture.

Both models feature double door locking systems to prevent unwanted door opening in rough seas and special racks designed for storing champagne bottles.

- Sturdy metal casing
- Robust handle
- Big storage room for 23 or 35 bottles
- Additional door lock included in the supply

Enjoy the pure luxury of storing wine or champagne at the perfect temperature:

- Built-In wine cellars for 23 or 35 bottles
- No aeration grills needed
- Profile of the door totally lined up with the doors of the furniture
- Interior light



Divino 23



Divino 35

### Product Overview: DIVINO Wine Cellars & Cooler

	Divino The One	Divino The Eight	Divino WC 23	Divino WC 35
Capacity	1 bottles	8 bottles	23 (27 max.)* bottles	35 (45 max.)* bottles
Internal shelves	–	2	3 wooden	5 wooden
Size in mm (W x H x D)	Ø 152 x 302	510 x 571 x 485	560 x 450 x 550	561 x 680x 550
Dimensions door in mm (W x H)	–	–	588 x 462	588 x 715
Weight (kg)	2	26	31	40
Power installed	60 Watt - 12V ONLY	60 Watt - 12/24 Volt	230 V 120 Watt - 115 V 120 Watt	230 V 120 Watt - 115 V 120 Watt
Cooling system	Thermoelectric	BD35F	Compressor CFC – free	Compressor CFC – free
Electronic thermostat	Self Regulation	1	1	1
Temperature	For white or red wine	For white or red wine	Mono	Mono
Internal light	27 Colour Option	Yes Led	Yes	Yes

\* 27 or 45 bottles if all the wooden shelves are removed from the wine cellar.

TYPE	ORDER NUMBER	DESCRIPTION
Divino The One	7N01TG9UP0000	DIVINO THE ONE 12V
Divino The Eight	7N08AA1CJ0000	WINE CELLAR DIVINO THE 8 12/24V
Wine Cellar 23	7N23AA5AJ0000	WINE CELLAR 23 220V/50Hz
	7N23AA6AJ0000	WINE CELLAR 23 110V/60Hz
Wine Cellar 35	7N35AA5AJ0000	WINE CELLAR 35 220V/50Hz
	7N35AA6AJ0000	WINE CELLAR 35 115V/60Hz



## Ensure warm water supply on board

Isotemp water heaters are specifically designed for use on yachts and boats. Only high quality components are chosen to ensure the best product performance. The marine water heaters are very robust and highly insulated to keep warm water available at all times and under all circumstances.

# Water heaters

## **BASIC**

Basic 24, 30, 40, 50, 75 108

---

## **SLIM**

Slim 15, 20, 25 108

---

## **SQUARE**

Square 16 108

---

## **SPA**

Spa 15, 20, 25, 30, 40, 50, 60 110

---

# Marine Water Heaters

## Basic, Slim and Square Range

Isotemp water heaters are specifically designed to be used on yachts and boats. The best product performance is guaranteed thanks to the use of high-quality components. Isotemp premium water heaters come with brushed stainless-steel casing and an innovative internal engineering. The highest performance is achieved by the optimized position of the engine water heat exchanger and the immersion heater. These components are positioned in the bottom of the tank where the water is at the lowest temperature in order to ensure an equal heating of the water in the tank. The water in and outlets are especially designed to minimize the mixture of cold and hot water.

### Isotemp Basic, Slim and Square Features

- Robust design
- Water tank in stainless steel
- 5 years warranty on water tank
- Extra thick insulation for high performance
- Extra-long, corrugated coils for high heat exchange efficiency
- External casing in stainless steel
- Stable fixing feet in stainless steel
- 360 ° adjustable mounting for easy installation also on bulkhead
- Electrical plug and play immersion heating element, especially engineered to heat also the water at the bottom of the tank
- Simple winter drain included in the safety valve
- Available also without thermostat mixing valve
- 750 W immersion heating element as standard



## Product overview: Marine Water Heaters

Slim	Type	Gross volume (l)	Dimension* L x Ø D (mm)	Weight (kg)	Rated pressure (bar)	Heating element (V)	Nominal power (W)
601531S000003	Slim 15	15	520 x 295	9.0	7.0	230	750 std
						115	750 std
602031S000003	Slim 20	20	645 x 295	10.5	7.0	230	750 std or 1200
						115	750 std or 1200
602531S000003	Slim 25	25	765 x 295	12.0	7.0	230	750 std or 1200 or 2000
						115	750 std or 1200
Basic							
602431B000003	Basic 24	24	470 x 395	12.5	7.0	230	750 std
						115	750 std
603031B000003	Basic 30	30	535 x 395	13.5	7.0	230	750 std
						115	750 std
604031B000003	Basic 40	40	640 x 395	15.5	7.0	230	750 std or 1200
						115	750 std or 1200
605031B000003	Basic 50	50	760 x 395	17	7.0	230	750 std or 1200 or 2000
						115	750 std or 1200
607531B000003	Basic 75	75	1050 x 395	24.5	7.0	230	750 std or 1200 or 2000
						115	750 std or 1200
Square			Dimension W x H x D (mm)				
601631QX00003	Square 16	16	400 x 560 x 180	15.5	5.0	230	750 std
						115	750 std
Double coil			Dimension L x Ø D (mm)				
602431BD00003	Basic 24	24	470 x 395	13.0	7.0	230	750 std
						115	750 std
604031BD00003	Basic 40	40	640 x 395	16.0	7.0	230	750 std or 1200
						115	750 std or 1200
607531BD00003	Basic 75	75	1050 x 395	25.0	7.0	230	750 std or 1200 or 2000
						115	750 std or 1200

\* Including thermostatic mixing valve.

\*\* Immersion heater 115 V/ 750 W and 115 V/ 1200 W also available. Material: Tank, engine water coil and all connections AISI 316; Outside cover and mounting feet: AISI 304; Electric immersion heater: Copper; Insulation: Polyurethane; Water connections: 1/2" inside and outside NPT and BSP pipe thread. Changes of the specification may be done without prior notice.

# Marine Water Heaters

## The Spa Range



The Isotemp Spa boilers are available in five different sizes ranging from 15 to 60 liters capacity. A stainless steel inner tank, a robust polypropylene casing and a 6 bar safety valve are the main features which guarantee the high marine quality standards.

### High Marine quality standards and optimized cost/quality ratio!

- 7 different sizes from 15 to 60 liters capacity
- AISI 316 inner tank
- 6 bar safety valve
- 5 years warranty on water tank
- Optional mixing valve
- Extra thick insulation for long-lasting heating performance
- Outer casing in high quality polypropylene
- Customizable with valves, voltage and nominal power of the heating element
- Water connections: 1/2"



### Product overview: Marine Spa boilers

Article number	Type	Gross volume (l)	Dimension (Ø x L) (mm)	Weight (kg)	Rated pressure (bar)	Heating element (V)	Nominal power (W)
6P1531SPA0003	Spa 15	15	310 x 450±5	7,5	6	230	750 std
						115	750 std
6P2031SPA0003	Spa 20	20	310 x 550±5	9	6	230	750 std
						115	750 std
6P2531SPA0003	Spa 25	25	310 x 650±5	10	6	230	750 std or 1200
						115	750 std or 1200
6P3031SPA0003	Spa 30	30	390 x 535±5	12	6	230	750 std
						115	750 std
6P4031SPA0003	Spa 40	40	390 x 640±5	14	6	230	750 std or 1200
						115	750 std or 1200
6P5031SPA0003	Spa 50	50	392 x 745±5	15,5	6	230	750 std or 1200 or 2000
						115	750 std or 1200
6P6031SPA0003	Spa 60	60	392 x 850±5	17,6	6	230	750 std or 1200 or 2000
						115	750 std or 1200

## Boilers with mixing valve

TYPE	ARTICLE NUMBER	DESCRIPTION
<b>SLIM</b>		
Slim 15	601531S000003	WATER HEATER SLIM 15L 230V/750W - MIXING VALVE
Slim 20	602031S000003	WATER HEATER SLIM 20L 230V/750W - MIXING VALVE
Slim 25	602531S000003	WATER HEATER SLIM 25L 230V/750W - MIXING VALVE
<b>BASIC</b>		
Basic 24	602431B000003	WATER HEATER BASIC 24L 230V/750W - MIXING VALVE
Basic 30	603031B000003	WATER HEATER BASIC 30L 230V/750W - MIXING VALVE
Basic 40	604031B000003	WATER HEATER BASIC 40L 230V/750W - MIXING VALVE
Basic 50	605031B000003	WATER HEATER BASIC 50L 230V/750W - MIXING VALVE
Basic 75	607531B000003	WATER HEATER BASIC 75L 230V/750W - MIXING VALVE
<b>SQUARE</b>		
Square 16	601631QX00003	WATER HEATER SQUARE 16L 230V/750W - MIXING VALVE
<b>DOUBLE COIL</b>		
Basic 24	602431BD00003	WATER HEATER BASIC 24L DOUBLE COIL 230V/750W - MIXING VALVE
Basic 40	604031BD00003	WATER HEATER BASIC 40L DOUBLE COIL 230V/750W - MIXING VALVE
Basic 75	607531BD00003	WATER HEATER BASIC 75L DOUBLE COIL 230V/750W - MIXING VALVE
<b>SPA</b>		
Spa 15	6P1531SPA0003	WATER HEATER SPA 15L SPA 230V/750W - MIXING VALVE
Spa 20	6P2031SPA0003	WATER HEATER SPA 20L SPA 230V/750W - MIXING VALVE
Spa 25	6P2531SPA0003	WATER HEATER SPA 25L SPA 230V/750W - MIXING VALVE
Spa 30	6P3031SPA0003	WATER HEATER SPA 30L SPA 230V/750W - MIXING VALVE
Spa 40	6P4031SPA0003	WATER HEATER SPA 40L SPA 230V/750W - MIXING VALVE
Spa 50	6P5031SPA0003	WATER HEATER SPA 50L SPA 230V/750W - MIXING VALVE
Spa 60	6P6031SPA0003	WATER HEATER SPA 60L 230V/750W - MIXING VALVE





## **Isotherm Air Heater – the perfect defrosting solution**

The air heater provides defrost power with radial fans and three power steps. It transfers the surplus of heat coming from the engine to defrost as well as to heat the cabin.



# Air Heat Exchangers

Air Heat Exchangers

114

# Air Heat Exchangers

The Air Heat Exchanger transfers the surplus heat coming from the engine using it to defrost as well as to heat the cabin. It has a radial fan with three power steps. It is equipped with four 60 mm hose brackets for the warm air distribution.



- Four outlets with Ø 60 mm
- The air intake can be canalized with hose adapters
- Fan speed regulation
- 12 or 24 V versions available
- Casing in stainless steel
- High heat output of 10 kW
- High temperature resistant components

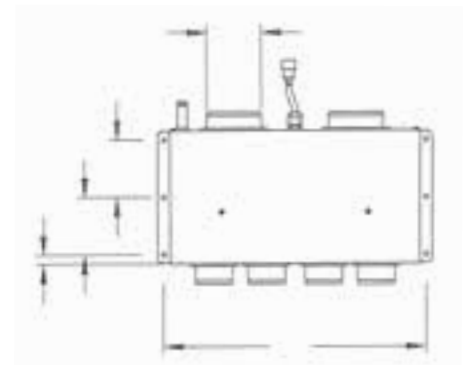
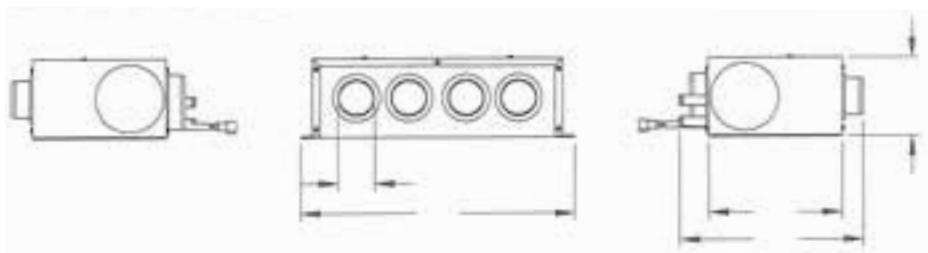

## Product overview: Air Heat Exchangers

Article number	Heat output (kW)	Dimension W x H x D (mm)	Volt (V)	Water pressure (bar)	Water hose connection (mm - ")	Weight (kg)	Power consumption (W)			Air-flow (m <sup>3</sup> /H)
							Low	Medium	High	
6D03A1DH00000	10	450 x 135 x 300	12	2.5	16 - 5/8	5,5	45	54	84	Up to 500
6D04B1DH00000	10	450 x 135 x 300	24	2.5	16 - 5/8	5,5	45	54	84	Up to 500

## Air Heat Exchangers

ARTICLE NUMBER	DESCRIPTION
6D03A1DH00000	ISOTHERM AIR HEATER 10kW 12V
6D04B1DH00000	ISOTHERM AIR HEATER 10kW 24V





## Ensure security on board

Boat owners using sophisticated and expensive, most technical equipment, create an increasing demand for security on board. On board safes ensure on board security.

## On Board Safes

Safe 10 118

---

Safe 30 118

---

# On Board Safes

Boat owners using sophisticated and expensive, most technical equipment, create an increasing demand for security on board. On board safes ensure on board security. The Isotherm safes are made of painted steel and available in two sizes. The larger model (Safe 30) is big enough to hold a laptop computer. The smaller model (Safe 10) is sufficiently large to carry smaller size devices.



Safe 30

Safe 10

- Steel painted with highly resistant grey coating
- Control panel integrated flush with the door
- Three independent locking systems  
(code number, mechanical, electronic key)
- Robust design
- Plenty of space inside

## Product overview: On Board Safes

Article number	Type	Dimension W x H x D (mm)	Weight (kg)
7F10000A00000	Safe 10 SAFE SECURITY BOX SMALL PAINTED, FLUSH DOOR	300 x 170 x 231	5.85
7F30000A00000	Safe 30 SAFE SECURITY BOX BIG PAINTED, FLUSH DOOR	431 x 221 x 350	12.3



# Indel Webasto Marine – Installation examples



*Cruise 195 Combi Inox*



*Drawer 65 Custom Panel*



*Cruise 85 Inox*



*Cruise 200 Inox*



*Wine Cellar Divino 23*



*Cruise 36 Inox painted*



*Clear Ice Maker & Drawer 65 Inox*



*Wine Cellar Divino 23*



*Cruise 49 Elegance with shiny stainless steel door front*



*Drawer 49 Inox*





*Cruise 130 Drink Inox*



*Cruise 130 Drink & Cruise 90 Freezer Inox side-by-side*



*Drawer 160 Inox painted*



*Cruise 90 Freezer Inox*



*Cruise 130 Inox*



*Cruise 36 Inox*



*2 X Drawer 16 Silver*



*Built-In 135*



*Cruisier 49 Inox*



## **Indel Webasto Marine – Present all over the world!**

Indel Webasto Marine is the successful Joint Venture of Italian based Indel B and Germany based Webasto. These two companies join forces to bring high quality solutions enhancing comfort in galley equipment for marine applications and to provide excellent customer service in all key boating areas. Our global dealer support network ensures local expertise for all our customers.



Indel Webasto Marine S.R.L.  
I-47863 Novafeltria (RN) Italy  
Telephone: + 39 0541 848030  
Email: [info@indelwebastomarine.com](mailto:info@indelwebastomarine.com)

[indelwebastomarine.com](http://indelwebastomarine.com)